



2025
CATALOG
ONE STOP POULTRY SHOP

FREE SHIPPING ON MOST ORDERS \$150+



**WE'VE GOT WHAT YOU NEED,
NO MATTER YOUR FLOCK!**



ON THE COVER

Customer Photo Submitted By:
Emilee Booz

"I love getting to show off my love for photography and my chicken buddies! These guys and gals 'crack me up' daily and bring joy to my life—even if that means crowing in the dark at 2:30AM! You will see my white rooster who likes to show you who's boss. So, I had to include one of him crowing his heart out!"

Table of Contents

Incubators & Brooders

4 Incubators

18 Brooders

Feeders & Waterers

23 Feeders

28 Waterers

Feeds & Supplements

36 Wonder Products

41 Health Aids

Enclosures

46 Fencing

52 Coops

56 Netting

Egg Handling

61 Nest Boxes

64 Egg Cartons

66 Egg Handling

Meat Bird Processing

68 Processing

77 Packaging

Bird Transportation

79 Bird Transport

82 ID Bands

Game Bird Supplies

85 Game Bird Supplies

Gifts

86 Books & Gifts

Baby Birds

90 Chicks

91 Meat Birds

112 Guinea Chicks

114 Turkey Poults

116 Ducklings

118 Goslings

Game Birds

120 Game Birds

123 Eggs for Hatching

Adult Birds

125 Adult Birds

Pigeons & Doves

128 Pigeons & Doves

Shipping

143 Shipping/Index/Info



BLUE RIBBON PRODUCTS

HELPING YOU SUCCEED SINCE 1923



Emoji Feeders

Durable feeders with a touch of fun. **Pg. 23**



Galvanized Feeders

Durable feeders made of galvanized steel. **Pg. 26**



Emoji Waterers

Durable waterers with a touch of fun. **Pg. 30**



Chick Waterers

Provide a constant and clean water supply for your chicks. **Pg. 30**



Shrink Bags

An 85 micron shrink bag kit - unlike any other on the market. **Pg. 77**



Transport Crates

The perfect heavy-duty crate for all your bird transport needs. **Pg. 80**

We have what you need to start or grow your flock! Stromberg's offers more products than the average box stores, and we know our birds! Come check us out at any of our six store locations or shop online - 24/7!

Woodland, CA
Marshall, TX
Hackensack, MN
Clarkson, KY
Winter Haven, FL
Wilkes-Barre, PA



Stromberg's INCUBATOR GUIDE

Discover our comprehensive range of incubators at Stromberg's, meticulously chosen to simplify your incubation projects. Incubators play a pivotal role in regulating four essential environmental factors crucial for successful egg hatching: temperature, humidity, airflow, and turning. By mastering these elements, we create optimal conditions for developing healthy, hatching eggs.

KEY ELEMENTS OF CONTROL IN INCUBATORS

While incubators may vary, they universally focus on controlling key elements:



Temperature Control: Electric heating elements manage temperature within the incubator, a critical aspect of the incubation process. The finest incubators ensure proper airflow over the heating elements and facilitate easy cleaning. Maintaining a temperature of 99.5 degrees is imperative for effective incubation.



Humidity Management: Humidity is crucial for developing the air sac in the egg and preventing the membrane from becoming too tough for the chick to break through. Control humidity using a water pan or an incubator-integrated humidification unit that heats the water. Adjust humidity higher three days before hatching as your incubator's manual will suggest.



Airflow Optimization: Eggs are porous, allowing oxygen to reach the developing chick. High-quality incubators provide consistent airflow without compromising temperature and humidity stability.



Turning Consistency: Regular egg turning prevents the bird from adhering to the egg's sides during development. However, during the three days leading up to the hatch day, cease turning the eggs. This allows the chick to orient itself within the egg, ensuring it can access the air sac before breaking through during hatching.

QUICK GUIDE FOR INCUBATION LENGTH

This isn't a comprehensive list but it will give you an idea of how long it takes to incubate these popular eggs.

CHICKEN EGGS
21 Days

RINGNECK PHEASANT EGGS
23 - 24 Days

MALLARD DUCK EGGS
28 Days

BOBWHITE QUAIL EGGS
23 Days

BANTAM CHICKEN EGGS
21 Days

CHUKAR PARTRIDGE EGGS
23 Days

KHAKI CAMPBELL EGGS
28 Days

COTURNIX QUAIL EGGS
17 - 18 Days

RCOM CABINET INCUBATORS

HATCH SUCCESS, WITH THE BEST!

Rcom Cabinet Incubator Features:



Easy-to-read precision digital controls



Hose input for built-in humidity pump system



Includes adjustable egg racks



Spacious design built specifically for large-scale incubation

Amazing Rcom Cabinet Features!

All Rcom Cabinets carried by Stromberg's have these great features, so regardless of your hatching needs, you are set for success!
(PP908 - Rcom Maru Deluxe Max 190 shown above.)

RCOM MARU DELUXE MAX PRODUCTS ARE RECOMMENDED FOR INCUBATING A VARIETY OF BIRDS:



FREE SHIPPING ON MOST ORDERS \$150+

THE RCOM CABINET LINE-UP

KEEP YOUR INCUBATORS CLEAN, FINISH INCUBATION IN A HATCHER!

Near hatch date, move your incubated eggs to the Rcom Maru Deluxe Hatcher 100! Hatching your eggs in a hatcher will maintain cleanliness in your primary incubators and keep newly hatched chicks safer!

Fits approximately **96** Chicken Eggs



Maru Deluxe Hatcher 100

PP901

Fits approximately **144** Chicken Eggs



Maru Deluxe Max 190

PP908

Rcom Maru Deluxe Hatcher 100

PP901

\$800.00

Features:

- Fits approximately 96 chicken eggs
- Easily adjust temperature & humidity
- Alarm system to ensure hatching success
- Easy-view door with LED light
- High-density foam with plastic coating provides excellent lifespan & insulation
- Integrated humidity pump & humidity control means built-in reliability & accuracy
- Four fans for increased airflow and temperature stability
- Easy-to-clean brooding box
- Ready-to-use right out of the box (Water reserve tank not included)

	Hatch Box Capacity per Species
Chicken	96
Duck	70
Quail	250
Pheasant/Chukar	112
Goose	36

Rcom Maru Deluxe Max 190

PP908

\$1,200.00

Features:

- Fits approximately 144 chicken eggs
- Easily adjust temperature, humidity, turning interval & angle
- Alarm system to ensure hatching success
- Easy-view door with LED light
- High-density foam with plastic coating provides excellent lifespan & insulation
- Integrated humidity pump & humidity control means built-in reliability & accuracy
- Four fans for increased airflow and temperature stability
- Adjustable egg racks included
- Ready-to-use right out of the box (Water reserve tank not included)

	Eggs per Egg Rack Style		
	Rack Capacity	Species Specific*	Universal
Chicken	3	144	108
Duck	3	90	69
Quail	6	744	600
Pheasant/Chukar	3	177	141
Goose	3	90	54

***WE CARRY THE EGG RACKS YOU NEED!** Check out our selection of species specific egg racks on page 11!



Maru Deluxe Max 1000

PP903

Water reserve not included, but easily sourced.

Rcom Maru Deluxe Max 1000

PP903

\$2,400.00

Features:

- Fits approximately 768 chicken eggs
- Easily adjust temperature, humidity, turning interval & angle
- Alarm system to ensure hatching success
- Easy-view door with LED light
- High-density foam with plastic coating provides excellent lifespan & insulation
- Integrated humidity pump & humidity control means built-in reliability & accuracy
- Four fans for increased airflow and temperature stability
- Adjustable egg racks included
- Ready-to-use right out of the box (Water reserve tank not included)

	Rack Capacity	Eggs per Egg Rack Style	
		Species Specific*	Universal
Chicken	16	768	576
Duck	16	480	368
Quail	32	3968	3200
Pheasant/Chukar	16	944	752
Goose	16	480	288

QUALITY INCUBATORS
Hatching chicks effortlessly!

Things to look for in the perfect incubator:

- Unit keeps consistent temperature
- Unit maintains proper humidity levels
- Eggs are regularly turned
- Unit is a clean, well-ventilated environment

Rcom Maru Deluxe Max products are recommended for incubating a variety of birds:



Sportsman 1502 Cabinet Incubator

Incubating and hatching made easy. You have complete control over the temperature and humidity settings. Set eggs each week and hatch the oldest eggs by transitioning them into the convenient hatching drawer in the bottom of the incubator. Just add plastic egg racks (sold separately). *Ships from manufacturer.*

Complete 2 in 1, Egg Incubator and Hatcher Combo!



PP391

\$1100.00

Features:

- Digital command center thermostat
- Temperature control
- Electronic egg turning control
- Audio/Visual alarms
- Easy-to-Use touch controls
- 3 turning trays
- Plastic hatching tray
- Hatching drawer
- Easy view window
- Easy to clean
- 110 Volt / 225 watt

Incubator Humidity Pads 10 pack

PP385

\$35.95

Package of 10 replacement humidity wick pads for cabinet model moisture pan. Wick pads are used to raise humidity during hatch period or during setting in arid or high altitude environments.



Sportsman Incubator Water Reserve System

DSPP351

\$64.95

Consists of 5 gallon reserve tank, connecting hose, with quick disconnect coupling and constant level humidity pan with 2 humidity pads, for increased humidity at time of hatch. *Ships from manufacturer*



Castors for Sportsman Incubators

PP419

\$47.95

This set of 4 casters will make it easier to move your cabinet incubator around for servicing, cleaning, & accessing eggs or trays. Easy to install on all cabinet models. Comes with base strips, mounting tape, & four locking casters.



DACB Hatching Tray Liners 25 Pack

PP420

\$19.95

Highly recommended, these disposable tray liners make for a quick and easy clean up of the plastic hatching drawer in the Sportsman incubators. 13.25" X 27.69".



The most popular incubators on the market!

The GQF circulated air cabinet incubators use the same principle that is used by large commercial hatcheries. They allow successful hatching of large quantities of eggs with ease, through automatically turning eggs in a controlled environment.



1202E Classic Sportsman Cabinet Incubator w/ Preset Electronic Thermostat

PP418

\$1050.00

With 3 wire turning trays and plastic hatching drawer, this is a great starter cabinet incubator. Same size and capacity as the 1502 Sportsman but with less automation for reduced cost. Features mechanically timed automatic egg turning, rugged dial thermometer/hygrometer, and a new multi-turn analog electronic thermostat system. Plastic board construction makes the cabinet better insulated, quieter, and easier to clean.

Capacity: 1368 Quail Eggs, 354 pheasant eggs, 270 chicken eggs, 198 turkey or duck eggs, and 36-45 larger eggs such as goose, peafowl, and emu. Actual capacity may depend on egg size.

Includes: 1 hatching drawer & Instructions

110-120VAC, 50/60 Hz, 325 W. TUV Listed. To keep eggs stable on the wire turning tray, don't forget your plastic egg racks (sold separately). Holds 6 egg racks.



1500 Cabinet Incubator

PP402

\$1050.00

Having incubation and hatching separate keeps your incubator clean. Three days before the scheduled hatch, move eggs into the 1550 Hatcher. Capacity: 1368 Quail Eggs (set and hatch 250 per week), 354 pheasant eggs, 270 chicken eggs, 198 turkey or duck eggs, and 36-45 larger eggs such as goose, peafowl, and emu. Actual capacity may depend on egg size. Preset thermostats can not be used for ratite or reptile eggs. Includes: 1 digital command center thermostat with humidity control, 3 turning racks, 1 moisture pan with 2 wick pads, operating instructions. 110-120VAC, 50/60 Hz, 325 W. TUV Listed. Holds 6 egg racks, sold separately.



1550 Digital Hatcher

PP392

\$1050.00

The 1550 Hatcher by GQF ensures sanitary hatching conditions. Unlike setting incubators, hatchers operate at slightly different temperature and humidity settings to obtain optimum hatch. Five hatching drawers will hold the setting of the 1500 Incubator. Move the setting eggs to the hatcher about 3 days before hatch. Hatching trays do not turn. Capacity approximately 1250 Quail eggs or 360 Chicken Eggs. Includes: 1 digital command center thermostat with humidity control, 5 hatching trays, 1 moisture pan with 2 wick pads, instruction booklet, 4 hatching tray covers. 110-120VAC, 50/60 Hz, 250 W. TUV Listed. Egg racks sold separately.

New level of performance!

Experience improved control for valuable and hard-to-incubate eggs. Humidity is a crucial factor in the success of hatching eggs. The OvaEasy Advance Series II incubators put accurate control of humidity in your hands.

OvaEasy 100: Eggs are set in trays on two tilting shelves which are set level for hatching. Hatching covers are provided to safely contain hatching chicks. OvaEasy 190 and 380: Eggs are initially set in three levels and are then moved to a large, removable hatching tray at the base of the incubator for the final stages of incubation and hatching. OvaEasy 580: Eggs are initially set in six levels and then moved to an OvaEasy Hatcher for the final stages of incubation and hatching. Hatching trays come complete with removable covers to contain the chicks.

Brinsea Incubation Specialists



Digital Control Center



Capacity per tray: Chicken: 36, Quail: 100, Partridge: 56, Pheasant: 47, Duck: 23, Goose: 15

- Ready out of the box, no assembly required
- Automatic temperature control in °F or °C fully factory calibrated
- High and low temperature alarms
- High and low room temperature alarms
- Cooling feature
- Programmable automatic egg turning - 30 to 180 minute intervals
- Single button press to level the shelves for easy tray access
- High performance, flexible incubator with hatching covers.
- Suitable for a wide range of egg sizes
- Clear, double-glazed observation door
- Sturdy metal frame, energy efficient, insulated cabinet
- Unique 'laminar airflow' to eliminate cold spots.
- 3 year manufacturer warranty
- INCLUDED FREE - set of universal egg trays with adjustable dividers to accommodate a wide range of egg sizes simultaneously
- PLUS 2 hatching covers to prevent hatchlings from escaping

Ships direct from manufacturer.

Brinsea® OvaEasy Series II Incubators

PP339 100 - 24"x24"x22"	\$1,550.00
PP329 190 - 37"x24"x22"	\$1,795.00
PP325 380 - 37"x37"x22"	\$2,395.00
PP336 580 - 48"x36"x22"	\$2,995.00
PP337 Hatcher - 37"x24"x22"	\$1,795.00
PP330 Humidity Pump	\$169.00

Don't forget - plastic egg racks and humidity pump (sold separately)



Don't forget the Humidity Pump!

Cabinet Incubator Essentials

Don't forget your egg racks and supplies!

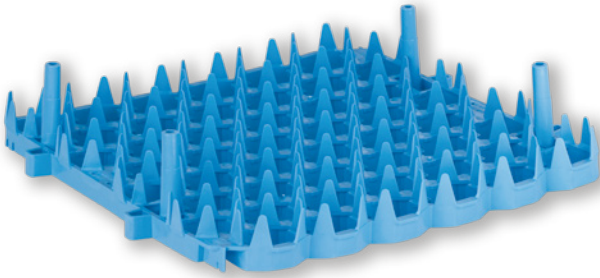

Universal Incubator Egg Rack

PP546 1 - 5 **\$7.95**
6+ **\$7.50**

Holds 48 eggs per tray, 6 trays are recommended for a total of 288 chicken eggs. Compatible with Rcom, Brinsea, and GQF incubators. Has tabs for a better fit in GQF 1500 series incubators.

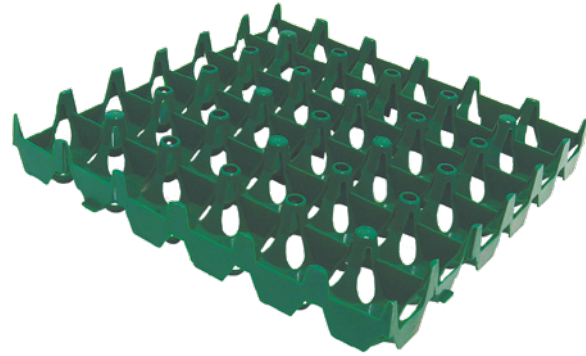

Jumbo Egg Incubator Rack for Turkey, Goose, Duck

PP516 1 - 5 **\$7.00**
6+ **\$6.50**

Holds 30 turkey, goose, or duck eggs per tray, 6 trays are recommended for a total of 180 eggs. One rack per setting tray must be trimmed to fit GQF incubators.

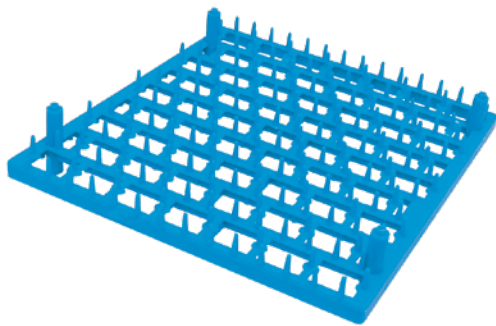

Bantam, Pheasant, & Chukar Egg Incubator Rack

PP252 **\$6.50**

Holds 59 eggs per tray, 6 trays are recommended for a total of 354 pheasant eggs. Compatible with Rcom and Brinsea incubators. Racks not stackable in the 1502 Incubator.

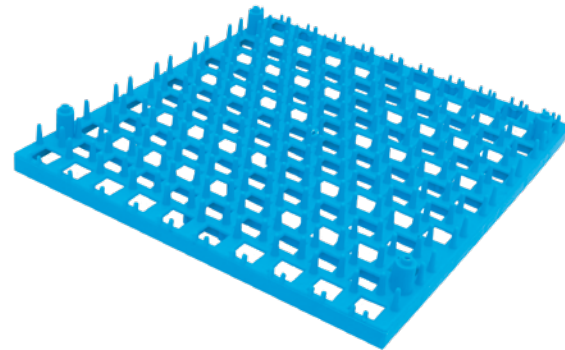

Quail Incubator Egg Rack

PP250 **\$7.50**

Holds 124 quail eggs per tray, 12 trays are recommended for a total of 1488 quail eggs. Compatible with Rcom and Brinsea incubators. Color may vary.



Tek-Trol Disinfectant

PH248 Aerosol Spray **\$10.50**
PH249 1 Gallon Concentrate **\$52.50**

All-purpose disinfectant, perfect for fogging an incubator and preventing airborne diseases. Sanitize eggs to eliminating shell-borne disease from passing through the egg shell. Wash down laying pens, create a disease free environment for your birds. 17 oz.



Virkon® S Disinfectant and Virucide 10 lbs

PH250 **\$89.95**

Virkon™ S is a science-based biocidal technology for animal health disinfection, which has been specifically engineered to provide an effective†, flexible, and convenient, modern formulated disinfectant solution for commercial livestock facilities, veterinary medical hospitals, and farm premises.

Proven effective against:

64 strains of virus†, 34 strains of bacteria, & 5 strains of fungi

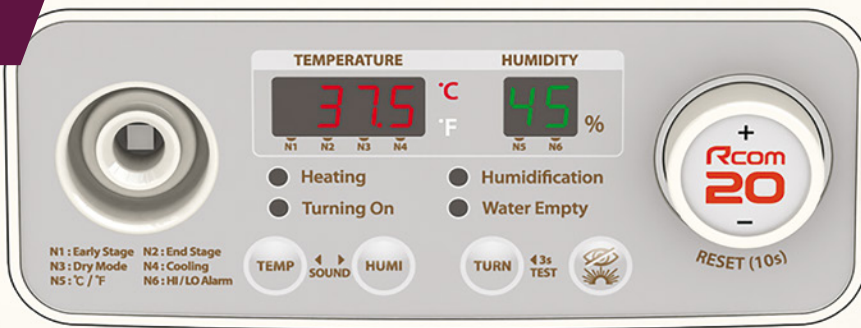

Meet the Rcom MAX Line

Rcom Incubators are made with top-of-the-line technology that is used and appreciated across the globe. With their innovative design and easy operation, you can be sure to have high hatch percentages every time.



Heated Water Reserve

Delivers precise humidity control for added hatching success

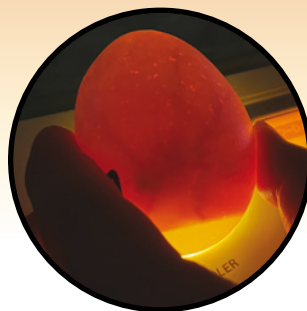

Built-in Egg Candler

Monitor your eggs for embryo development with your incubator

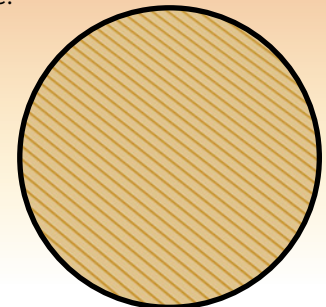

Textured Flooring

Gives your chicks needed traction in the incubator to avoid spraddle leg



Rcom 20 DO MAX Incubator

- PP897 Incubator
- PP531 Chicken Egg Tray
- PP532 Goose Egg Tray
- PP533 Quail Egg Tray

\$349.95
\$13.95
\$13.95
\$13.95

- Easy View Window
- Temperature adjustment
- Humidity control
- Adjustable turning
- Comes with 1 adjustable egg tray
- Alarm for low water and temperature
- Body of incubator comes apart for easy cleaning

Capacity: Chicken: 20, Quail: 52, Goose: 10
 Egg racks sold separately.



Rcom 50 DO MAX Incubator

- PP898 Incubator
- PP534 Chicken Egg Tray
- PP535 Goose Egg Tray
- PP536 Quail Egg Tray

\$679.95
\$25.00
\$25.00
\$25.00

- Easy View Window
- Temperature adjustment
- Humidity control
- Adjustable turning
- Comes with 1 adjustable egg tray
- Alarm for low water and temperature
- Body of incubator comes apart for easy cleaning

Capacity: Chicken: 48, Quail: 116, Goose: 25
 Egg racks sold separately.



Meet the Rcom PRO Line

ALL OF THE FEATURES OF THE MAX LINE , PLUS THE FEATURE BELOW

Take your incubation to the next level with the Rcom PRO line of incubators! These incubators carry all the amazing features of the MAX line (shown on the adjacent page), plus the additional features listed below!

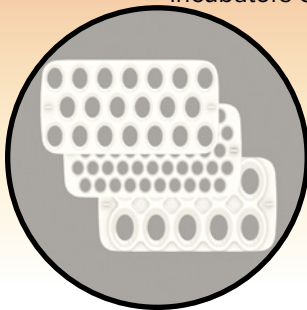

Egg Racks Included

Specially designed chicken, quail, and goose egg racks included



Wi-Fi Compatible

Connect your Rcom PRO to calibrate and monitor your incubation process



Auto & Custom Modes

Easily incubate based on bird species in auto mode or pick custom settings control all aspects of your hatch.



20
Chicken
Eggs

Rcom 20 DO PRO Incubator

PP899

\$495.00

- Easy View Window
- Temperature adjustment button, add water and you're good to go
- Beginner Mode - Hit one button, add water and you're good to go
- Advance Mode - customize your temperature, humidity & degree of turn
- Comes with all egg trays: Chicken, Goose & Quail
- Alarm for low water and temperature
- Body of incubator comes apart for easy cleaning

Capacity: Chicken: 20, Quail: 52, Goose: 10



48
Chicken
Eggs

Rcom 50 DO PRO Incubator

PP900

\$834.95

- Easy View Window
- Temperature adjustment button, add water and you're good to go
- Beginner Mode - Hit one button, add water and you're good to go
- Advance Mode - customize your temperature, humidity & degree of turn
- Comes with all egg trays: Chicken, Goose & Quail
- Alarm for low water and temperature
- Body of incubator comes apart for easy cleaning

Capacity: Chicken: 48, Quail: 116, Goose: 25

Egg Candling



Powerlux LED Egg Candler with Battery Pack

PP465

\$39.95

Intense LED bulb and a powerful lens makes inspecting eggs a breeze! Dark or speckled eggs are no match for the powerful light source and eggs big or small are easily inspected with rubber adapters.

Features:

- Includes rubber adapter for candling eggs big or small
- Powerful LED light
- Includes cord for use AND battery pack

Please Note:

Determining an egg's fertility is key to deciding if it should remain in your incubator. Removing infertile eggs will help prevent contamination and can improve your hatch rates.



OvaScope Battery Powered Egg Scope

PP331 High Intensity

\$84.95

Now with the OvaScope egg scope you can watch the live embryo develop inside the egg. This innovative aid to egg candling improves the clarity and visibility of the egg and it's contents by completely blocking out ambient light, slightly magnifying the image of the egg and allowing the viewer to rotate the egg smoothly as it is observed. Battery powered for convenience (4 AA batteries included) the OvaScope egg candler uses high output high efficiency LED illumination - so no bulbs to replace and no concerns about overheating the eggs during inspection. Suitable for any size egg up to duck/turkey eggs. Supplied with a small black ring to seal against the egg shell of smaller eggs. The OvaScope egg candler can be fitted with a webcam and is ideal for demonstration purposes or classroom use. Supplied with a set of 4AA batteries. For longer life it can be used with rechargeable AA batteries. The Standard Intensity scope is for pale shells.



Angry Rooster High Intensity Egg Candler

PP469

\$55.75

This high intensity candler will work great for your candling needs. It will candle both white and brown eggs and will even candle those hard to see through dark brown eggs. Includes two rubber adapters. One for regular sized chicken eggs and a smaller adapter for quail eggs. Handy stand so you can stand the candler straight up when you are using. This candler has a cord that you will use when you are recharging the unit. Battery power to last 20- hours continuously on. Also works as a cellphone charger and flashlight. LED lights stay cool during your candling.



Brinsea OvaView Egg Candler

PP327 High Intensity

\$49.95

PP326 Standard Intensity

\$39.95

Works with quail or chicken eggs. 20 hour battery life. This LED light allows you to easily candle both white and brown eggs while keeping your eggs cool. Includes a flexible black ring to seal against the egg shell and a smaller ring for smaller eggs. Uses rechargeable AA batteries. The High Intensity lamp is for darker eggs (quail, pheasant). The Standard Intensity lamp is for pale shells (one ring, most species).

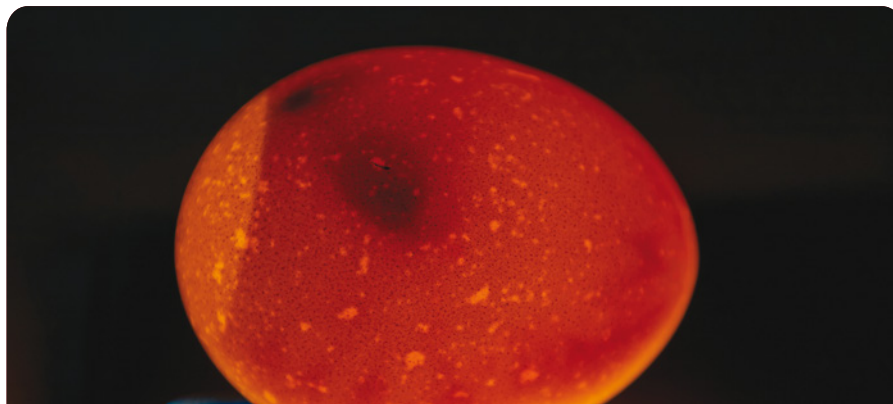



GQF Incubator Thermometer
PP486 **\$6.50**

Lightweight thermometer, designed to be placed directly on top of the eggs to give you an egg level temperature reading. Compatible with all incubators and most brooders. 3.5" X 6.5"



Digital Thermometer Hygrometer Remote Sensor
PP490 **\$22.25**

Simply place the remote sensor in your incubator and it will wirelessly give you your temperature and humidity readings on the base unit. The unit sends back temperature readings every 10 seconds.



Small Digital Thermometer Hygrometer
PP491 **\$10.50**

2.5" wide x 3.5" height x 1" deep. Temperature range of 14°F-122°F and humidity range of 20%-90%. Requires 2 AAA batteries, not included.



TemLog 20H PDF Temperature and Humidity Data Logger
PP259 **\$42.00**

Figure out where your hatches are going wrong with this easy-to-use temperature and humidity logger. It generates a PDF report automatically without any software needed. Just leave the unit in the incubator to record at a set interval. Displays and records C/F temperature and % PH at 0.1° and 0.1% PH resolution.



GQF Digital Incubator Hygrometer
PP489 **\$27.95**

Compact and easy to read! Temperature choice of F or C, and humidity is displayed as a percentage. Min/Max recorded.



Pocket Thermo-Hygrometer for Temperature and Humidity
PP487 **\$39.95**

Pen-style with clip. Humidity range 10%-90%. Auto power off to save on battery or can convert to non-sleep modes for continuous readings. Fits most incubators including the Styrofoam and cabinet models. AAA battery included for about 150 hrs of use. (-10°C to 5°C) with +/- 1 deg. F accuracy. Temp range 14°F to 122°F.



Taylor Ultra High Capacity Digital Kitchen Scale
PP498 **\$28.50**

Measure and track egg weight loss! Helps you effectively measure humidity in the incubator. Capacity is 13 pounds and is accurate up to 0.01 ounces. Works great for egg sizing! Batteries included.

Stromberg's says:

A quality thermometer and hygrometer are must have tools for incubating and raising chicks!

IN AN INCUBATOR:

Maintaining the correct temperature and humidity in an incubator is one of the key factors in producing a successful egg hatch rate. A thermometer and hygrometer will assist in ensuring you have the ideal incubation conditions for the bird species you are hatching.

IN A BROODER:

Hatchlings as well as weeks old chicks need access to consistent warmth. A thermometer is a vital tool to ensure your chick's environment is at the ideal temperature for their age range.



Get Started Raising Chicks

Discover the ultimate convenience in caring for your baby chicks with Stromberg's thoughtfully curated bundles.

We offer three distinct packages:

1. Starter Kit: This kit includes a radiant heat plate brooder, a waterer, and a feeder, offering essential tools to get started, though additional items may be needed for complete setup.

2. Comprehensive Bundles (Second and Third Options): Enhance your chick-raising with our Comprehensive Bundles, thoughtfully curated for all your needs. These bundles provide essential equipment and supplementary items for a comprehensive solution, ensuring you can confidently meet your chicks' diverse needs.

The Essentials

CHICK STARTER KIT



Chick Starter Kit

SB105

\$55.00

Kit Includes:

- PP611 1 - Chick Heating Plate 10" x 12"
- PH131 1 - 32 oz Plastic Jar Feeder Base
- PW125 1 - 32 oz Plastic Jar Waterer Base
- PW126 2 - Plastic Waterer/Feeder Jars
- PH425 1 - Peck N' Grow Packet

This kit pairs perfectly with our PP957 Stand Up Chick Brooder (sold separately) on page 21.

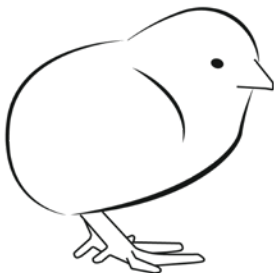

Comprehensive Bundles

COMPREHENSIVE PACKAGE #1



Comprehensive Package #1

PP442

\$97.50

Package Includes:

- PP110 1 - Single Lamp Brooder
- PP609 1 - Stainless Steel Tripod (Brooder Lampstand)
- PP112 1 - Infra-Red Heat Bulb
- PP645 1 - 7 x Panel Cardboard Brooder
- PW532 1 - 1 Gallon Waterer Jar
- PW533 1 - 1 Gallon Base Regular
- PW534 1 - 1 Gallon Base No Drown
- PH204 1 - Vitamins & Electrolytes Mix
- BM706 1 - Guide to Raising Poultry Book
- PH425 1 - Peck N' Grow Packet
- PH098 1 - Turbo Feeder
- PH154 1 - Turbo Feeder Lid
- PP486 1 - Thermometer

COMPREHENSIVE PACKAGE #2



Comprehensive Package #2

PP446

\$162.75

Package Includes:

- PH614 1 - Comfort Brooder Heat Plate 16" x 24"
- PP616 1 - Cover for PP614 16" x 24"
- PP645 1 - 7 x Panel Cardboard Brooder
- PW532 1 - 1 Gallon Waterer Jar
- PW533 1 - 1 Gallon Base Regular
- PW534 1 - 1 Gallon Base No Drown
- PH204 1 - Vitamins & Electrolytes Mix
- BM706 1 - Guide to Raising Poultry Book
- PH425 1 - Peck N' Grow Packet
- PH098 1 - Turbo Feeder
- PH154 1 - Turbo Feeder Lid
- PP486 1 - Thermometer

Both these packages provide the equipment you need for successful chick-raising. Just add chicks, bedding, and feed!

Brood Your Chicks Safely

Heated brooder plates provide a safe and efficient way to help your chicks grow into healthy chickens. By offering a secure heat source and allowing chicks to move freely, they make raising hatchlings both simple and effective.

Radiant Heat Plate Chick Brooders

PP611	For up to 20 chicks - 10" x 12"	\$50.50
PP612	For up to 50 chicks - 17" x 25"	\$64.95

Discover the ideal solution for keeping your chicks warm while keeping your costs low with our Radiant Heat Plate Poultry Brooder. Designed to prioritize safety and efficiency, these brooder heat plates boast remarkable features to ensure optimal conditions for your feathered companions.

Key Features:

- Energy-Efficient Warmth:**
 - Our brooder heat plates utilize only 10% of the energy consumed by a standard 250-watt lightbulb. Experience substantial energy cost savings without compromising on the warmth your chicks need.
- Feather-Friendly Environment:**
 - Unlike traditional brooders, our radiant heat plates allow birds to move freely between heated and non-heated areas. This freedom promotes healthier feathering, ensuring your chicks feather out more fully for robust growth.
- Safe and Cost-Effective:**
 - Eliminate the worry of fire hazards with our brooder's safe and efficient radiant heat technology. You can rest easy knowing that your chicks are kept warm without incurring unnecessary energy expenses.

Invest in the well-being of your poultry with our Radiant Heat Plate Poultry Brooder — where warmth meets efficiency for thriving chicks and reduced energy costs.



Comfort Chick Brooders

PP613	Small Plate - 12" x 12" (up to 20 chicks)	\$52.50
PP615	Small Plate Cover	\$14.95
PP617	Corner Plate - 15 3/4" x 15 3/4" (up to 25 chicks)	\$59.95
PP618	Square Plate - 16" x 16" (up to 50 chicks)	\$59.95
PP614	Large Plate - 16" x 24" (up to 50 chicks)	\$78.75
PP616	Large Plate Cover	\$36.75

Safe alternative to heat lamps! Has two sizes and would be ideal for 20 to 50 chicks or waterfowl. Uses a tenth of the electricity of typical suspended infrared lamps, because the chicks are in contact with the warm underneath surface. This brooder grows with your chicks with the adjustable legs. These brooders are also much safer than using heat bulbs, which when left unsecured can start barn fires. Don't forget your clear plastic covers to keep chicks from climbing on top of the brooder. Pairs well with our 1 Liter Drinking Bottle with Hinged Lid (PW313).



Sweeter Heater Chick Brooders

PP654	For up to 35 chicks - 11" x 16"	\$120.75
PP653	For up to 65 chicks - 11" x 30"	\$157.50
PP655	For up to 85 chicks - 11" x 40"	\$168.00
PP609	Stainless Steel Heat Lamp Tripod	\$14.95

This is an excellent safe and low-power brooder for your chicks. A non-breakable, energy-efficient, long-lasting (three-year warranty), sealed/washable, and reliable specific area heater. Excellent for a brooder heater for chicks, you can also use this as a heat source when your birds are cold. The Sweeter Heater pairs perfectly with the Stainless Steel Tripod.



Safe & Effective Heating



AVOID DEVASTATING COOP AND BARN FIRES BY USING THIS HEAT LAMP WITH A BUILT-IN SAFETY SWITCH!



Turns off when tilted over 30°



Three way switch enables charging between 100% or 50% power and power off



Durable ceramic socket fits easy-to-find standard 250W bulb

BROOD YOUR CHICKS OR HEAT YOUR CHICKEN COOPS WITH THIS ONE-OF-A-KIND HEAT LAMP WITH BUILT-IN SAFETY FEATURES TO GIVE YOU PEACE OF MIND!

Heat Lamp with Safety Switch

PP995

\$49.95

This fire resistant chick and coop heater is a safe and reliable, smaller heat lamp! When this heat lamp is tipped past 30 degrees the safety switch engages and turns off the unit, giving you peace of mind. This lamp has multiple uses besides being an awesome addition to your brooders or coop. It's also great for use with baby goats, sheep, or even dogs. Also, there is no need to search for a special bulb, this heat lamp uses an easy to find, standard 250W bulb. Bulb not included.

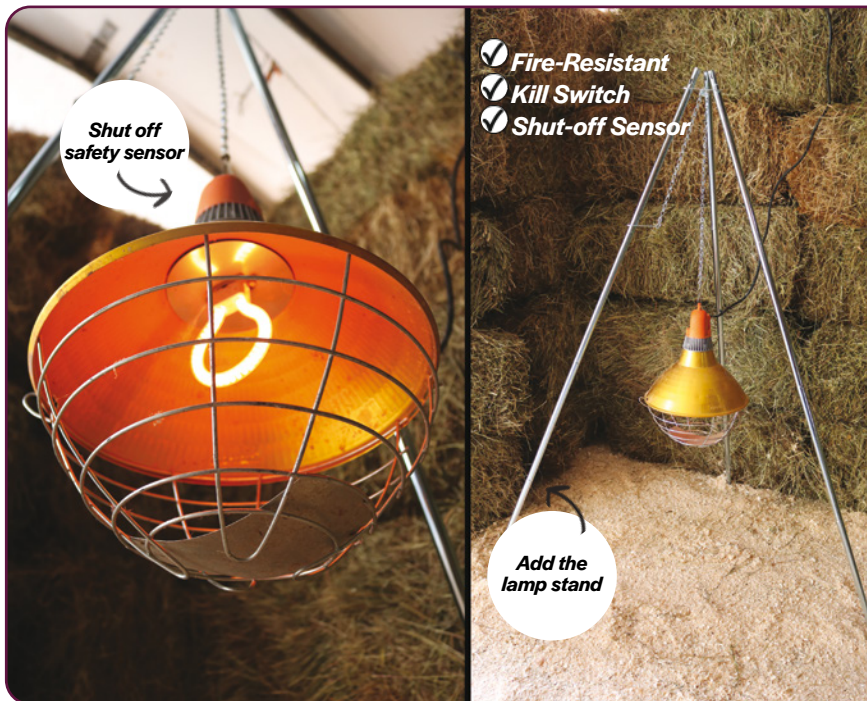

- ✓ Fire-Resistant
- ✓ Kill Switch
- ✓ Shut-off Sensor

Carbon Fiber Heater

PP996	600W Carbon Fiber Heater with Bulb	\$95.00
PP997	600W Carbon Fiber Replacement Bulb	\$24.25
PP998	1200W Carbon Fiber Heater with Bulb	\$110.00
PP999	1200W Carbon Fiber Replacement Bulb	\$27.50
PP609	Stainless Steel Heat Lamp Tripod	\$14.95

Safe, fire-resistant coop heater features a kill switch if the unit is tilted past 45 degrees. Keep your chicken coop warm with this carbon fiber heater. Hang these higher than you would a regular heat lamp to efficiently disperse heat over a large area. Includes automatic shut off sensor for added safety (protects your coop from dangerous heat lamp fires). Available in 600W or 1200W. Complete with bulb.

Chick Raising Solutions



*Don't forget the
Hanging Single
Lamp with Guard!
Available below!*

*Works great with
lamp brooders or
heat plate brooders!*

Stand Up Chick Brooder

PP957

\$225.00

A great solution to brooding! Keep debris off the floor and save space. Easily add an infrared lamp to provide the chicks with healthy heating when required. There is plenty of space for all the chick essentials - waterers and feeders. Holds 50 chicks. Easily see inside the brooder with perforated steel sides and top.

The wire floor keeps animals separate from the floor tray, making it easy to clean. Assembly required.

38.5"L x 18.5"W x 24"H
(headroom height is 9.5")



Automatic Thermostat Four Lamp Brooder

PP602

\$140.00

A great energy saver! The thermostat controls 2 of the 4 lamps and includes chain to hang from ceiling. Galvanized steel reflector, wire guard, 3 prong cord, 110 V. Capacity 350 chicks. Weight is 7.5 lb. Bulbs not included.

Hanging Single Lamp Brooder with Guard

PP110

\$18.00

Provides chicks with a warm, dry environment. Heat-resistant ceramic socket and double wire bulb guard for safety. Features 6-foot electrical cord with polarized male prongs and scratch-resistant clamp with ball joint for easy positioning. Corrosion-resistant 10.5" aluminum shade has a built-in hanger. Reflectors extend over lamps and protects them from moisture from the ceiling. Guards protect lamps and keep them out of litter. Clamp included. Capacity 100 chicks. Bulb not included.

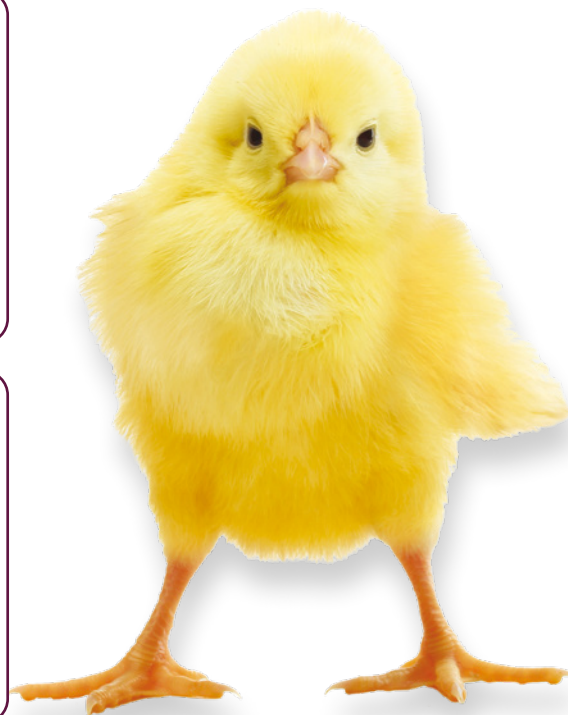

Cardboard Brooder Panels

PP645

\$11.75

Set of 7 individual cardboard panels that connect to form a simple but effective brooder area for your chicks.

*Don't forget
your bulb!*



Infrared Heat Bulbs

PP112

\$7.50

250 watts
Shatter resistant design
Perfect for use in brooder lamps

Box-Style Brooders

Reduce stress in young birds by providing plenty of heat, fresh air, light, space to eat, and sanitary conditions in a confined area. Clear plastic panels allow full and easy viewing of the brooder's interior. Choose between heated brooders or non-heated growout pens.



Chick & Quail Brooder

PP650	Chick & Quail Brooder	\$475.95
PC135	Caster Base	\$133.95

Galvanized steel construction. Poly feeder and drinker included. Feed trough fills from outside and holds approximately 7 pounds. Universal water drinker with 3-liter capacity and self-cleaning trough. Capacity: 100 day-old chicks, 50 four-week-old chicks or 100 quail chicks to the fourth week. PVC coated wire mesh floor. Dropping pan is easily removed for cleaning. Overall size is 42" L x 27" W x 19.5" H (interior height 10"). 250-W heating element thermostatically controlled. 115 V. 2 pilot bulbs included. Assembly required.



Five Deck Poultry, Game Bird Battery Brooder

PP660	Stacked Five Deck Poultry Game Bird Battery Brooder (pictured)	\$1999.95
PP668	Auto Water Kit for Brooder	\$89.95

Five heated units! Brooders stack and bolt together on brooder base. When purchased in set, one lid is supplied. Clear panels make a perfect display for feed stores, etc. Drop pans and floors can easily be removed for cleaning. Includes 6-plug electrical outlet strip with 4 ft cord. 110V. Floor mesh 1/2". Overall dimensions: 32" W x 38" D x 65" H. Includes brooder/pilot bulbs and built with rugged castors. Pair PP660 with PP668! *Products sold separately.*



Heated!

Universal Box Brooder

PP665	Universal Box Brooder	\$349.95
PP661	Automatic Watering Kit	\$89.95
PP662	Caster Base for Box Brooder	\$228.95

Use for almost any type of bird! Each side panel comes with adjustable gate to regulate openings for chick type and age to allow them access to three feed or watering troughs. Any trough can be converted with the auto watering kit. Thermometer and water thermostat are included and are accurate to one degree. Floor is 1/2" mesh which allows droppings to easily pass through. For quail chicks especially, it is recommended to use Universal Brooder Liners (PP680) paper on top of the wire mesh for the first 4-7 days. Drop pans are made of lightweight aluminum are easily removed for cleaning. Approximate capacity to 4th week: 100 quail, 50 chukar or pheasants or 100 poultry chicks to 2nd week. Overall dimensions 32" x 38" x 12" (9" headroom). 110-V. 250W heater.



Stacked Grow Off Pen, One for Birds & Chicks

PP678	Stacked Grow Off Pen, One for Birds & Chicks	\$1260.00
PP676	Non-Heated Grow Off Pen	\$283.50
PC137	Expansion Kit	\$99.00

This can be the start of a very lucrative enterprise, producing approximately 48 chickens a month in a very limited space. Put day old chicks from a hatchery or incubator into the brooder for warmth, feed, and water. After four weeks, move 24 birds into each grow off pen and put 48 new chicks in the brooder. That's 96 birds kept comfortably in less than 11 square ft. 49 inches tall. Includes one brooder with 2 blue pilot bulbs, two expanded grow off pens, brooder base, and casters.

Shown - one heated and two non-heated

Baby Chick Feeders



Chicken Emoji Poultry Feeder 9 LB

PH174	1 Feeder	\$20.95
PH574	5 Pack	\$89.95

The 9 lb Chicken Emoji Poultry Feeder is crafted from translucent, anti-bacterial plastic. Its durable design features an indicator, enabling effortless monitoring of food levels. With a rounded body and a removable lid, refilling and cleaning this feeder becomes a breeze. Whether placed on the ground or hung up, this permanent feeder adds a touch of fun to your poultry setup.

32 oz Plastic Jar Waterer/Feeder



PW126	Jar	\$1.50
PH131	Feeder Base	\$3.25
PW125	Waterer Base	\$1.50

Economical choice! One quart (32 ounce) plastic jar fits all glass jar feeders and waterers. A great alternative to glass jars. Don't forget the feeder base to complete the set.

Trough Style Feeders



PH191

PH097

PH191	20" Metal Trough Chicken Feeder	\$11.95
PH097	12" Red Plastic Ground Plastic Feeder	\$4.25

Made of heavy-gauge galvanized steel, this trough features individual holes to minimize waste, ensuring that feed is distributed evenly and efficiently among your flock. The sturdy construction and easy-to-clean design make it an ideal choice for maintaining a healthy and productive poultry environment.

Available in plastic as well.

Turbo 8 lb Chick Feeder



PH098	Feeder Only	\$3.55
PH154	Lid Only	\$5.25

A gravity flow feeder for baby chicks. Circular in design. Feeder is 7.5" high and the base is 11.5" in diameter. Trough is 1.5" wide. Narrow trough prevents chicks from getting into feed and scratching. Made of sturdy plastic. Easy to clean. Will hold up to 8 lb of feed. Snaps together. Not adjustable. Lid rests on top, sold separately.

Hinged Feed Control 16 lb Universal Feeder



PH136		\$22.95
-------	--	----------------

This feeder is designed to be used for baby chicks on up to full grown game birds and poultry. It's great for pigeons too! Designed with a hinged lid and has feed control within the feeder to regulate the height of the feed in the pan, an essential part of economic feeding. The trough is 1.5" high with a 12" diameter. Height is 20". 16 lb Capacity.

Bantam, Game Bird Small Plastic 5 lb Chick Feeder



PH134	Single	\$18.95
PH234	4 pack	\$60.00

A perfect size, may be placed within most all game or bantam chick brooders, 12" L x 6" W x 5.5" H. The very low one inch feeding edge is just right for the smaller chicks. Feed capacity 5 lb. Sturdy plastic.

We have more feeders!

For any size flock, we have the feeder you need.



Silo Feeder

PH194

\$84.00

This new high-capacity feeder makes feeding your flock a breeze. The 65-pound capacity means that you can fill it with a whole bag of feed with room to spare! Its translucent body lets you know when you're running low on feed. The feed saver grill makes it harder for you birds to waste feed.

It's Easy to clean

- 6" stand keeps the feed trough out of the bedding.
- Large lid makes this a breeze to clean. Just open it up and wipe it down.
- Easy to remove grill makes it simple to wipe down the feed trough when needed.

High Capacity that is easy to fill

- 65-pound capacity.
- Fill the feeder less often giving you more time to enjoy your birds.
- The large lid makes it easy to fill.
- The feed saver grill means your birds will not waste feed saving you money.



DON'T FORGET A WATERER FOR YOUR BIRDS!

The PH194 - Silo Feeder pairs perfectly with our PW079 - Silo Waterer found on page 28.



Scan for our full selection of feeders and waterers online!

Econo Feeder with Lid

Quality construction made of galvanized steel with a solid bottom. Includes two hooks to attach to the cage. Simply drill two holes in the back of the feeder to hang from the wall.



11.5"
PH447 **\$12.75**



9"
PH444 **\$11.75**



7.5"
PH441 **\$12.75**



3.5"
PH435 **\$10.50**

Feedomatic Treadle Feeder

Prevent feed waste with the Feedomatic Treadle Feeder! This innovative treadle design keeps disease-carrying pests out and protects feed from moisture and elements within!



Feedomatic Treadle Feeder

PH190 **\$68.25**

Designed with the highest-quality in mind, the Feedomatic Treadle Feeder lowers feed waste with it's unique design. The feed is safely contained within the feeder and only made accessible when the weight of a chicken standing on the treadle opens it. Made of plastic and metal making it quiet - meaning the birds aren't scared of a loud feeder. This prevents disease carrying pest like rats and mice from contaminating feed as they would with a traditional open feeder. Metal and UV-resistant design gives this feeder the edge when protecting feed from elements and adds durability and strength for years of use!

Feedomatic Treadle Feeder:

- Keeps feed dry & fresh
- Unique design prevents feed spills
- Keeps disease-carrying pest out
- Strong and durable design

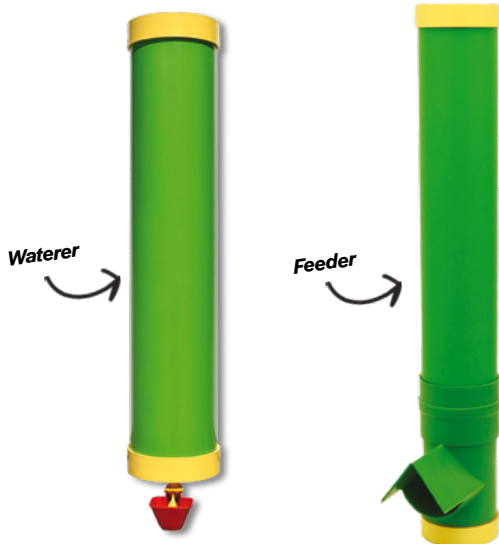

High End Hen Waterer & Feeder

PW169 Waterer	\$43.95
PH137 Feeder	\$49.95

The High End Hen Waterer keeps your chickens' water clean and sanitary. Allows you to add more water without entering the pen. It holds 2 gallons of water so you will not need to water daily if you have a smaller flock.

The High Hen Feeder allows you to feed your chickens without entering the pen. Keeps your shoes clean while doing your morning chores.



25 lb Wall Mounted Feeder

PH160 **\$93.95**

Ideal for small pens of poultry, bantams, or game birds. 25 lb feed capacity. Bottom slants forward with feed level adjustment. Durable galvanized steel construction. No cover. 18" x 16" x 9" D.

Hanging Feeders

Save space and feed with hanging feeders.



50 lb Capacity Hanging Feed Saver Feeder

PH151	Single	\$52.95
PH641	20 pack	\$695.00

Perfect for chickens, turkeys, and other grown birds. Made from strong, durable, heavy-duty plastic. Includes feed cover and feed saver grill. Lid included. 22" W x 24" H. Trough is 4.5" high.



22 lb Game Chick Hanging Feeder

PH135	Single	\$39.95
PH335	10 Pk	\$312.95

Specially designed for use with young quail, pheasant, or baby chicks. Manufactured with a built-in grill molded into the body. Made of high-density polyethylene plastic. Capacity of 22 lb. 15" W x 16" H. Trough 2" wide, 1.5" deep.



20 lb Hanging Feed Saver Feeder

PH153	Feeder Only	\$37.95
PH173	Feeder - 6 pk	\$190.95

Very popular feeder. The body of this feeder is manufactured with a built-in molded plastic grill. The pan has an inward rolled lip which works great as a feed saver. It has a double-crossed inward bracing at both the top and bottom. The cylinder has a capacity of 20 lb., Depending on the density of the feed. Adjusts up to 17" W x 20" H. Trough is 2" wide x 3" deep.



44 lb Capacity Metal Hanging Feeder

PH193	Feeder	\$38.95
PH693	Feeder - Pack of 5	\$169.95

This galvanized hanging feeder is made from heavy duty steel with rolled edges. The rolled edges make sure you do not cut your hand while moving or assembling the feeder. It has a secure system for locking the feeder in the desired feed flow height, ensuring the feeder does not come apart while filling. It can be used both free standing and hanging. Both hanging feeder covers the PC154 and the PC155 fit this feeder. Holds 44 Pounds.



50 lb Capacity Hanging Feed Saver Feeder

PH311	Single	\$39.95
PH611	20 pack	\$650.00

Perfect for chickens, turkeys, and other grown birds. Made from strong, durable, heavy-duty plastic. Includes feed cover and feed saver grill. Lid included. 22" W x 24" H. Trough is 4.5" high.

Hanging Feeders enhance efficiency and save space in your chicken runs. Add a lid to your hanging feeder to further protect feed from the elements!



Plastic Hanging Feeder Cover
PH155 **\$12.95**



Plastic Hanging Feeder Lid
PH154 **\$5.25**

Large Capacity Feeders

Feed more with our large capacity feeders, made for rain or shine.



50 lb Rain Shield Feeder

PH152	Single	\$103.95
PH642	20 pack	\$1,596.00

The best small-to-medium capacity range feeder ever made. The lid and rain shield are made of durable plastic molded into one piece. This unit goes down over the feeder body to the correct height from the pan to make an excellent rain and sun shield. The whole top unit is removed for easy filling. This unit is equipped with a grill for feed saving. The pan depth is 4¾" and the diameter is 22". The overall height is 24". Cover diameter 24".



50 lb Range Quail & Pheasant Feeder

PH156	Quail Feeder (2.5" pan depth)	\$103.95
PH646	Quail Feeder - 20 pack	\$1,596.00
PH310	Pheasant/Chukar (3" pan depth)	\$103.95
PH640	Pheasant/Chukar Feeder - 20 pack	\$1,596.00

With a large demand for a size and correct lip height for game birds, these two feeders will fill the requirements. The range feed cover and lid have been redesigned for quail, chukar, or pheasants. The Pheasant Feeder has a feed saver lip. 16.5" diameter.



300 lb Large Capacity Range Feeder

DSPH157	Pheasant/Chicken Size Pan	\$436.95
DSPH158	Quail Size Pan	\$436.95

Constructed of strong, durable UV resistant plastic with reinforced ridges allowing for approximately 300 lb capacity of mash feed and 250-270 lb capacity of pellet feed. New locking lid design virtually eliminates lid blowing off. Newly designed rain/weather shield has 3½" sides to prevent feed getting wet in rainy conditions. Diameter of shield is 36". Flow rate is adjustable by mounting feeder pan to body at ideal feed flow rate. Instructions included. **Ships direct from manufacturer.**



Weatherproof!

900 lb Gamebird Range Feeder

DSPH675		\$1050.00
---------	--	------------------

Low & wide rain shield reduces the amount of rain that can blow into the pan during a heavy storm. Large pan circumference provides more feeding space for birds, which results in fewer feeders per pen. Narrow stepped pan design to reduce the amount of fines that can build up in the pan. Six uniquely designed support legs that will not allow feed to block up behind them, preventing mold build up. Adjustable feed flow (1.25" to 3.25") opening 45° cone to ensure adequate feed flow into the pan. Easy to open/close lid that can adapt to fit an automatic feed line. Large capacity reduces the number of times you need to fill each feeder. 27.5" wide opening to allow for easy filling either by hand or with an auger. **Ships direct from manufacturer.**

Silo Waterer

The perfect waterer to pair with your Silo Feeder!



Silo Waterer - 12 Gallon

PW079

\$84.00

This high-capacity Silo Waterer allows you to have the water your birds need with the features you've always wanted. See through body lets you know when you need to fill it. This waterer works with a float valve, so it is easy to operate, and you don't have to count on seals or gaskets that are prone to fail!

It's Easy to clean

- 6" stand keeps the water trough out of the bedding.
- Large lid makes this a breeze to clean. Just open it up and wipe it down.

High Capacity that is easy to fill

- 12 Gallon Capacity gives your birds the water they need.
- Fill the waterer less often giving you more time to enjoy your birds.
- Fill the waterer by using the smaller hose opening or by opening the larger cover

DON'T FORGET A FEEDER FOR YOUR BIRDS!

The PW079 - Silo Waterer pairs perfectly with our PH194 - Silo Feeder found on page 24.



Scan for our full selection of feeders and waterers online!



Add OregaPro to your water solution!

OregaPro is the perfect addition to your water mixture to help keep your flock happy and healthy! OregaPro is specially created to boost your birds' immune system and is even helpful in times of stress!

Check out OregaPro and the Wonder line starting on page 36!

Galvanized & Plastic Waterers

Our large capacity waterers allow you to see how full it is and keep your flock happy.

Metal works best in the winter!



PW106

PW107



Little Giant Galvanized Double Wall Waterers

PW106	3 Gallon - Single	\$39.95
PW096	3 Gallon - 2 pack	\$74.95
PW107	5 Gallon - Single	\$44.95
PW097	5 Gallon - 2 pack	\$84.95
PW170	Heater Base	\$56.95

- Heavy gauge steel
- Brass valves and rubber seals produce a positive water shut off
- Seams are constructed and tested to prevent leaks
- Features a locking pin
- For poultry and game birds

Constructed of heavy-gauge, galvanized steel and available in four sizes. Edges are rolled for safety and feature arched inner handles for added strength. Copper spring and neoprene seal produce a positive water shut-off. Seams are constructed and tested to prevent leaks. Sloped to prevent perching. Double wall waterers also feature a locking pin.



Little Giant Poultry and Game Bird Waterer

PW109	3 Gallon	\$43.00
PW110	5 Gallon	\$54.00
PW111	7 Gallon	\$62.00
PW112	Small Trough Cap with 3 O-Rings	\$9.95

This large-capacity poultry waterer features a vacuum-sealing O-ring cap that creates an automatic water flow. Made of dent-proof, heavy-duty translucent plastic that allows you to see the water level. The easy to fill jar snaps completely onto the base, and the rugged handle makes transport around the yard easy. This is a durable unit that will stand up to plenty of use.



PW086

Add legs to your PW085 Bucket Waterer reduce bedding in your water! Sold separately.

Bucket Waterer

PW085	5 Gallon Waterer	\$44.95
PW086	Legs for Waterer	\$6.95
PW087	10 pk - 5 Gallon Waterer	\$389.95

This waterer is a great addition to any coop. Buy the legs separately to keep it up off of the ground and reduce bedding in the waterer. As with most waterers, it is easier to fill it with a hose rather than carrying it full.



Plastic Waterer - 3 Gallon

PW094	\$38.95
-------	----------------

This solidly built plastic drinker offers a unique filling option. You can fill it from the TOP! If you have ever tried a bottom filled "flip" waterer you know these are the right waterer for you! This waterer has a 3 gallon capacity and is easy to fill.



Emoji Waterer

PW179	1.5 Gallon Capacity	\$11.95
PW579	5 Pack	\$51.95

This new waterer is going to be the hit of the coop. Printed with a fun design it will make you smile every time you fill with water. 1.5 gallon capacity this waterer is made from heavy duty UV resistant plastic.



Holder easily mounts to cage & coop walls!

1 Liter Drinking Bottle with Hinged Lid

PW313	Drinking Bottle	\$5.95
PW315	Drinking Bottle Holder	\$3.25

This versatile 1 liter drinking bottle is equipped with a drinking nipple for your chicks and poultry. Leak free and is also UV resistant. Pairs perfectly with holder that is sold separately.



Baby Chick Waterer with Float Valve

PW091		\$8.95
-------	--	---------------

This small drinking cup stays dry until your animal drinks, thanks to its smart design. The closed system ensures clean, fresh water and promotes better hygiene. Easy to install with the included galvanized bracket, it's a practical solution for your poultry. The yellow clapper releases water into the cup only when pecked, preventing contamination and keeping water fresh longer.



All Poly Top Fill Waterer Trough

PW306	4 Gallon	\$60.00
PW307	7 Gallon	\$70.50
PW136	Universal Electric Heater	\$73.50

Rugged construction ensures long life. The water level is easily viewable with gallon markers on the sides. Easy to carry and clean. Safe with medications. Both troughs are 2" wide x 1.5" deep. These can also be used with universal electric waterer heater.



Plastic Jar Waterer/Feeder

PW126	32 oz Jar Only	\$1.50
PW143	58 oz Jar Only	\$5.25
PW125	Waterer Base	\$1.50
PH131	Feeder Base	\$3.25
PW137	No-Drown Waterer Base	\$1.75

Fits all glass jar feeders and waterers. A great alternative to glass Mason jars. Both size jars fit perfectly with the waterer base, feeder base, or No-Drown Waterer base.



3 Gallon Poultry Waterer with Metal Handle

PW127		\$21.00
-------	--	----------------

Features a built-in handle for easy portability.



1 Gallon Screw on Jar and Bases Waterers

PW532	Jar Only	\$4.00
PW533	Quail & No Drown Base	\$4.95
PW534	Regular Chick & Juvenile Base	\$2.25

Change the water less frequently with our gallon waterer. Wide mouth is easy to clean. Get both bases and use the narrow chick and juvenile base for your baby chicks and the wide-mouth base as they get older.

Automatic Waterers

Make life easier with our variety of automatic waterers. Hook it up and forget it!



Fits garden hose! Never worry about filling the tank again!

Little Giant Auto Poultry Waterer with Cover

PW130

\$44.95

This automatic waterer has 30" hose that will connect directly to your pressurized water source. This gives your birds continuous access to fresh clean water. Automatic float valve controls the water level so there is no spilling or overflow. Oversized cover extends beyond the edge of the bowl to keep debris out of the water. Angled cover keeps birds from roosting on the waterer. Not recommended in freezing temperatures.

- Provides a continuous flow of fresh water for adult poultry
- The included hose attaches to a standard garden hose and there is no need for a pressure reducing valve
- Automatic float controls the water level so there is no spilling or overflow
- Cover prevents roosting and keeps debris out of the water
- Easy to assemble and easy to clean



Automatic Trough Waterer for Duck & Geese

PW416

\$133.95

Works with pressurized water system. Float keeps trough filled automatically. Trough is deep enough for ducks and geese to get their head into waterer. Valve guard is included. Trough length is 29.5", drink height is 5". 2-gallon capacity. Some assembly required. 1/2" NPT fitting.



Little Giant Pressurized Automatic Waterers

PW131 Universal Waterer (6" W x 2" Deep)

\$32.95

PW132 Chick Waterer (7" W x 2" Deep)

\$35.95

PW133 Turkey Waterer (8" W x 3" Deep)

\$42.00

PW134 Bowl Guard (Prevents Roosting)

\$10.95

The Little Giant poultry waterers have been used by poultry experts for years. These dependable waterers hook up to any standard 1/2" NPT pipe to provide a limitless supply of clean water. Safely operates between 20-50 psi. Pick your waterer, tripod kit, and don't forget the guard.



3 Gallon Duck/Geese Automatic Waterer

PW308

\$39.95

Works with pressurized water sources and will fit a garden hose or faucet. Adapted for use as a poultry waterer. Because of its depth and larger size, the waterer works great for ducks and geese with their larger bills. It will also work for chickens, turkeys, and other fowl. Features an adjustable float arm covered by a metal shield so you can adjust the water level. 3-gallon capacity. 16" diameter. 30" hose length.



Automatic Water Troughs - 2 pack

PW185

\$86.95

Automatic water trough for game birds, pigeons and poultry. Use the attaching brackets to attach to your cages or mount on your stand. Attach to water faucet, turn water on plastic float with brass valve maintains constant water level. Made of durable plastic with rotating reel on top to keep birds off. Equipped with 4-foot hose. Ready to attach to faucet. Maximum Pressure 50 Psi. Length: 18" Width: 3.5" Depth: 2"

The expandable, customized automatic drink system!

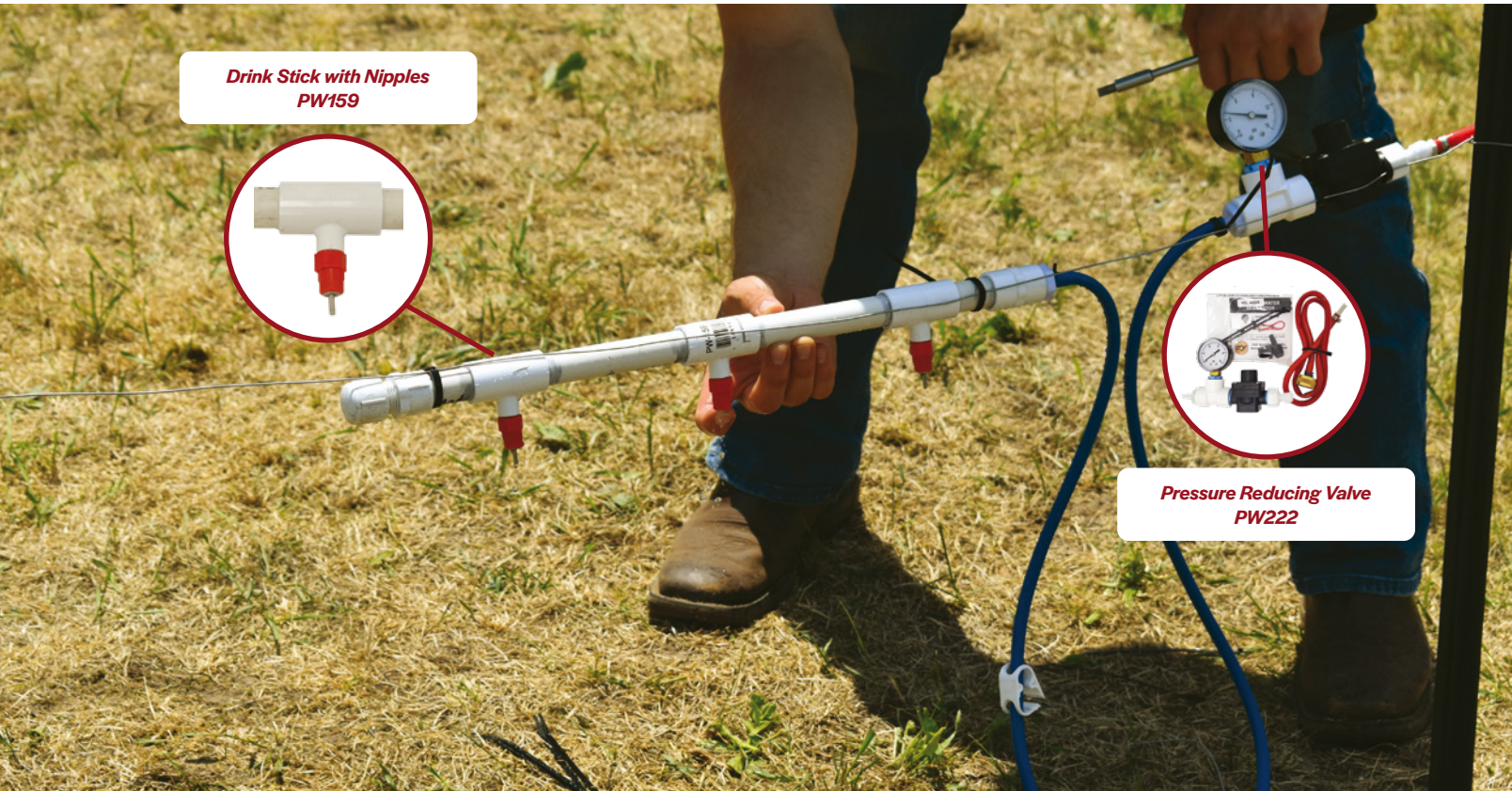

Drink Sticks - DIY to Fit Your Watering Needs!

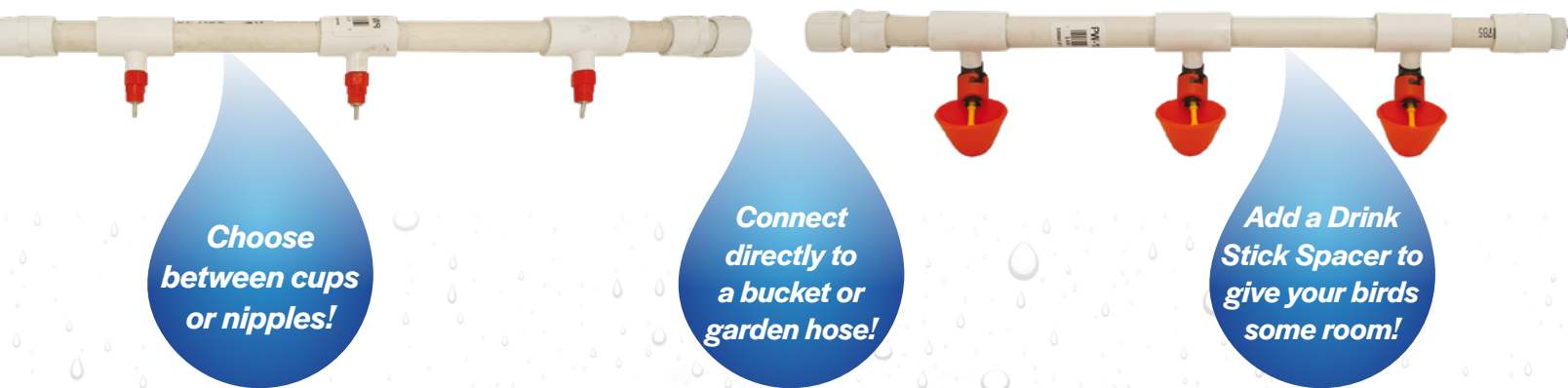

Drink Sticks and Accessories

Make your chores a little bit easier with the drink stick - the expandable automatic drinker system for poultry! Easily hook up this system to either a gravity-fed system or a garden hose. Plus, choose from a cup or nipple style watering system. Expanding is simple! Just unthread caps and thread multiple sticks together. Use one drink stick alone or combine to make it as large as you need.

Connect your drink stick to a bucket!



Drink Stick with Cups	PW180	\$39.00
Drink Stick with Nipples	PW159	\$31.50
Drink Stick Spacer	PW181	\$6.50
Pressure Reducing Valve	PW222	\$46.95
Through Bucket Fitting	PW182	\$5.25

DIY automatic watering system!

Design the perfect watering system for your flock! Whether small or large, we offer all the components you need to make the perfect watering system.

Step 1: Select your water source control



Automatic Floating Valve 4 ft
PW187
Attach this automatic watering valve to the 30" or 60" watering trough.
\$26.95



Pressure Reducing Valve
PW222
This valve can be used for a small and large systems. Includes 5/16" and 1/4" hose barsbs and 2ft normal pressure hose with connector.
\$46.95



Through Bucket Fittings
PW182 1/4"
PW231 5/16" (pictured)
Connect your drink sticks to buckets with these through fittings.
\$5.25
\$7.50

Step 2: Select your flock's drinking component



Horizontal Mount Poultry Nipples - 4 pack
PW277
Easy to install, helps keep water clean, and prevents disease. Birds access water by tapping the solid stainless-steel trigger. Accommodates up to 4 birds each.
\$4.75



Drinking Cup - 5 pk
PW274
Provides clean water. Molded, heavy-duty, durable plastic watering cups. Install on the side of a bucket, providing an automatic release of water every time your bird pecks the yellow trigger.
\$5.95



Vertical Mount Poultry Nipples - 4 pack
PW158
Save money and transform any bucket or PVC pipe into a poultry watering device! Don't forget the bucket!
\$4.75



Mounting Brackets for Drinker Cups - 5 pack
PW220
Cage bracket attaches to tubing to space out cups easily. Works with PW274!
\$19.95

Step 3: Select your accessories



Tube Clamps - 18 pack
PW221
Clamps used to secure 5/16" tubing and fittings.
\$5.95



Plastic Shutoff Clamps 5/16" or 1/4" - Each
PW267
Clamp flexible tubing to shut off the water flow.
\$1.95



PVC Pressure Adapter (Adapts ADPV to 1/2" PVC)
PW233
Hook up your pressure reducing valve to 1/2" PVC pipe. Purchase 1/2" PVC pipe locally. Drill 5/16" holes 8" apart, in the side of 1/2" PVC pipe and attach bracket with PVC adhesive.
\$7.25



5" Plastic Tubing Ties - 20 pack
PW227
These are UV resistant ties that are used in the tubing.
\$3.25

Step 4: Select your extra customizable components



Plastic Tees 1/2" 10 pack
PW226
Add a Tee to connect hoses and expand your watering system.
\$13.95



Low Pressure Tubing

PW191	1/4" - 50 ft	\$24.95
PW225	5/16" - 50 ft	\$25.95
PW224	5/16" - 100 ft	\$43.95

Can be used for a small and large systems. Get the size and length for your system. Color may vary.



Tubing Splicers 5/16" - 10 pack
PW223
Package of 10 plastic hose splicer for 1/4" hose or tubing.
\$6.95



Hanging Nipple Waterer

PW080

PW081 10 pk

\$29.00
\$280.00

This hanging nipple waterer is a great way to deliver water to your birds in the most sanitary way. By providing clean and fresh water, you ensure the health of your flock. Has three recessed nipples so you can set the waterer down without breaking or dirtying the nipples.



Built-in hooks clip to any type of wire hutch or coop

Galvanized Metal Cage Cups with Hooks

PW166 1/2 Pint

PW167 1 Quart

\$5.95

\$6.50

Keep food and water clean with galvanized metal cups that work equally well for small animals and poultry. Built-in hooks clip wherever you want, to any type of wire hutch or coop, indoors or out. Heavy-duty galvanized steel for years of service, with rolled edges for safety.



Plastic Cage Cups with Hooks

PW144 Pint

PW145 Quart

\$3.75

\$3.95

These heavy-duty plastic watering cup may be just what you need! It can also be used for feed! These cups have hooks that attach to your cages or pens. The pint cup measures 4.5" L x 3.25" W. The quart cup measures 8" L x 3-3/4" W. Both cups have a depth of 2".



Converts bottles into waterers!

Soda Pop Bottle Waterer

PW160 12 pack

PW174 3 pack

\$16.95

\$4.95

Perfect for cage or pens. Waterers fits through 1" square opening in cage or pen to supply adequate water for small birds or small animals. Includes spring to hold bottle. Easy to use and clean.



We've got the perfect poultry watering solution for you!

Whether your flock is large or small, we've got the perfect waterer for your birds to thrive!



Scan for our full selection of waterers online!

Winter Watering

Ensure your birds have access to fresh water, even during the cold months!



Winter Poultry Heated Drinker and Waterer Base

PW149

\$43.95

Keep your poultry's water from freezing over with this efficient base heater! This water heater keeps drinkers and waterers from freezing in some of the most extreme winter temperatures, which include temps even as low as -20°F. The Winter Poultry Heated Drinker and Waterer base also comes with adjustable brackets to help steady and brace waterers placed on it, making it the perfect addition for your flock! Do not expose to rain, wind or snow. Designed to be used inside a coop or enclosure.



Flexible Winter Drinker Heating Cable w/ 24V Adaptor

PW176

\$24.95

Keep your animal's drinker/waterer from freezing in winter with the Flexible Drinker Heating Cable! This low voltage (24V) cable is a safe and adaptable solution for your animal's cold weather drinking needs as it fits most any drinker. Simply submerge the stainless-steel coated area of the cable within the waterer, with the connection piece of the heating cable inside as well. The cable maintains steady heat to the water supply preventing it from freezing. Perfect for chickens/poultry, rabbits, and pets!

Important:

- While the cable and connector are submersible, the adaptor must always stay dry.
- This product is meant for use in water only.
- Make sure power cord is inaccessible to damage from animals and other elements.
- Do not expose to rain, wind, or snow. Designed to be used inside a coop or enclosure.



Electric Heater Waterer Base

PW136 For Metal & Plastic Waterers (pictured)

\$73.50

PW170 For Metal Waterers Only

\$56.95

Keep your birds drinking water all year round with two different styles.



Click Shield Cord Lock

HD308

\$9.50

Fast & inexpensive way to weatherproof any power cord, while also eliminating irritating & dangerous disconnects.



Wonder



Coop Spray

COOP ODOR ELIMINATING SPRAY



Wonder Coop Spray

Coop Spray is a simple and easy solution to controlling odors and keeping your coop smelling fresh. Natural enzymes start by breaking down odor-causing bacteria to stop its growth and fresh pine scent instantly leaves a clean smell, providing lasting odor control. Coop Spray only utilizes ingredients that are safe for people and animals compared to lesser products may rely on harmful chemicals. Coop Spray is multi-surface friendly and is safe for freshening up coops and cages, barns, bedding, dirt floors, vehicles, trash cans, shoes and more.

- All-in-one odor control that utilizes a fresh pine scent and natural enzymes
- Eliminates odors safely without harmful chemicals
- Can use anywhere: coops, barns, garages, vehicles, homes, and more
- Ready to use formula, simply shake and spray
- Made in the USA!

PH259 Wonder Coop Spray

\$14.00



Do my chickens need supplements?

Giving your chickens supplements can be a game changer for your flock. Disease prevention & overall vitality are important when it comes to raising healthy & happy birds!

- Supplements can provide essential nutrients to chicks & poultry during critical or high stress periods
- Supplements that contain probiotics support digestive health & the absorption of important minerals in your birds
- Essential oil based supplements can provide a natural immune system boost

Our Wonder supplements help aid the growth and development of your flock to their best potential as egg-laying and meat birds,



Peck N' Grow

- Nourishment for those first critical hours!
- Necessary carbohydrates, protein, probiotics

PH425 Peck n' Grow - 100 Chick Dosage
 PH426 Peck n' Grow - 2500 Chick Dosage

\$4.95
\$37.95

Probiotics

- Supports digestive health and aids in nutrient absorption
- Live probiotics to help maintain a natural healthy gut

PH551 Probiotics Concentrated - 200g

\$19.95

Probiotics+ with Electrolytes & Vitamins

- Feed to chickens in all stages of life
- Helps strengthen immune systems
- Aids nutrient absorption
- Promotes high quality eggshells

PH550 Probiotics+ - 200g

\$36.75



OregaPro

- Created to boost your bird's immune system, especially in times of stress
- 100% natural oregano-based product

PH415 OregaPro Supplement for Flock Health - 500ml

\$21.50

PH416 OregaPro Concentrate Supplement for Flock Health - 1l

\$35.95

Wonder



Wonder GRUBS

Dried Mealworms

The premium treat for your flock!



- High Protein
- High Fiber
- No Additives
- No Preservatives
- All-Natural



Treats for healthy, happy birds!



Wonder Grubs

Wonder Grubs Dried Mealworms are a 100% natural, high protein, and high fiber treat for your flock! Wonder Grubs contain nothing but premium dried mealworms with no additives or preservatives. This makes for a healthy treat that is great for birds, reptiles, fish, hedgehogs, and other small critters! Wonder Grubs Dried Mealworms can even be rehydrated by soaking in warm water for 10 minutes. Store in a cool dry place. No refrigeration is required. Contains 5 lb of dried mealworms.

PH525 Wonder Grubs (Dried Mealworms) - 5 lb

\$37.95

Wonder Grubs Guaranteed Analysis	
Crude Protein (min)	52%
Crude Fat (min)	20%
Moisture (max)	7%
Crude Fiber (max)	10%



Wonder Grubs Black Soldier Fly Larvae

Engage the super strength of Wonder Grubs! Your flock and critters naturally love insects. Treat them with their favorite snack. They'll love the flavor, and you'll feel confident that it's filled with the nutrition they need.

Wonder Grubs Calcium Craze is naturally fortified with protein, calcium, healthy fat, phosphorus, and lysine to promote stronger eggshells and a SUPER FLOCK! Contains 5 lb of Dried Black Soldier Fly Larvae.

PH560 Wonder Grubs Black Soldier Fly Larvae - 5 lb

\$38.95

Wonder Grubs Black Soldier Fly Larvae Guaranteed Analysis	
Calcium (max)	4%
Crude Fat (min)	30%
Lysine (min)	2%
Phosphorus (min)	.5%
Moisture (max)	7%
Crude Fiber (max)	9%
Crude Protein (min)	34%



Wonder Garden Grubs

Engage the super strength of Wonder™ Garden Grub! Your flock and critters naturally love veggies, mealworms, and seeds. Treat them with their favorite snack. They'll love the flavor, and you'll feel confident that it's filled with the nutrition they need. Wonder™ Garden Grub is packed with whole treats that you can see, so you don't have to wonder what your birds are eating. Contains a 6 lb mix of cracked corn, peanuts, yellow peas, dried mealworms, green peas, carrots, sunflower seeds

PH570 Wonder Garden Grubs - 6 lb

\$31.50

Wonder Garden Grubs Guaranteed Analysis	
Crude Protein (min)	16.9%
Crude Fat (min)	21%
Moisture (max)	12%
Crude Fiber (max)	8%

Sanitation Helps Prevent Flock Disease

Kills pathogens 10x faster



Meets EPA criteria for use against SARS-COV-2, the virus that causes COVID-19

Virkon® S Disinfectant and Virucide 10 lbs

PH250

\$89.95

Virkon™ S is a science-based biocidal technology for animal health disinfection, which has been specifically engineered to provide an effective*, flexible, and convenient, modern formulated disinfectant solution for commercial livestock facilities, veterinary medical hospitals, and farm premises.

Proven effective against:

64 strains of virus†

•34 strains of bacteria

•5 strains of fungi



PI Quat 20 Cleaner - Disinfectant - Sanitizer 1 Gallon

PH251

\$26.25

PI Quat 20 is a 20% dual chain quaternary ammonium disinfectant/sanitizer registered for use in processing plants, dairies, animal quarters, poultry and turkey farms, hatcheries, and kennels. May also be used to sanitize previously cleaned food grade eggs in shell egg and egg processing plants.



Tek-Trol Disinfectant Cleaner Concentrate

PH249 1 Gallon

\$52.50

PH248 Aerosol Spray

\$10.50

TekTrol is a synthetic disinfectant that can be used in a variety of animal care facilities Works against a broad spectrum of gram-positive and negative microorganisms. Excellent solubility and works through standing dirt.



Traffic C.O.P. Foot Pan Powder 18 lbs

PH252

\$54.95

Unique blend of chlorine, deodorizers, silicates, and acid impregnated zeolites designed for foot pans in poultry and swine facilities. It does not freeze or evaporate and is effective for approximately 2 weeks. It provides an easy, affordable way to clean footwear, while controlling moisture and odor.



FortiGuard Solid Surface Sanitizer 2 lbs

PH254

\$15.95

Floor treatment that is EPA registered to kill food pathogens such as Listeria, Escherichia coli (E. coli), Salmonella, and Avian Flu. Helps to prevent slippage, fills in small, hard-to-reach areas. Plus, it lasts longer than many competitors.



Universal Pan

PH253

\$9.95

Place a foot bath pan next to the entry of your pens and add the disinfectant of your choice to the pan. We recommend Virkon S, Traffic C.O.P, and Sterilex Ultra Step.

durvet



Durvet Vitamins & Electrolytes Concentrate

PH204 Easy-to-mix jar **\$10.95**
 PH219 Concentrate **\$6.50**

Promotes healthy growth & combats stress due to extreme temperatures, overcrowding & transportation. Supplementing electrolytes during these times will help maintain proper balance of water & pH throughout the bird's body. Contains vitamins A, D, E, B complex & C. Now in two sizes and in an easy to measure 100-gram bottle (one scoop for one gallon, enough for 20 gallons). The concentrate makes 110 gallons (use 1 oz. to 27 gallons).



Durvet Probiotics Daily for Poultry

PH202 **\$12.50**

This product can be used for all poultry to give them a boost using naturally occurring microorganisms. Aids in poultry's digestive health and with nutrient absorption. Easy to use: one scoop per gallon of water. 100 grams.



Durvet Durastat with Oregano for Poultry

PH203 **\$9.95**

A natural alternative to boost immunity and stimulates water intake in your chickens. Can be used with other Durvet poultry soluble products. Easy to use: one scoop per gallon of water. 100 grams.



Durvet Layer Boost with Omega 3

PH205 **\$15.50**

Ideal for laying hens, Layer Boost provides the needed nutrients to improve the quality and quantity of eggs produced by your hens. 100 grams.

Protect Your Flock From Disease



VetRx Veterinary Aid

PH201

\$14.75

A few drops of VetRx every few weeks can relieve a multitude of illness symptoms in birds including: colds, croup, scaly legs, and eye worms. May be used in sprays, vaporizers, drinking water, and feeds. Follow instructions for use. 2 oz.



Poultry Protector All-Natural Non-Toxic Coop Spray

PH246 33.9 fl oz Concentrate - Treats 25-100 birds

\$22.25

Cleans away parasites naturally. Use on the birds, their bedding and surrounding grounds. Studies show that when fleas, mites and lice are not available on or around your birds they become less aggressive and less stressed. Allows them to increase egg production and gain weight.

*Recommended for
1 day old chicks*



Vaccine for Marek's Disease 200 mL - 1,000 Dose

PH239

\$57.95

Vaccinate one-day-old chicks only to aid in the prevention of the signs and lesions of Marek's disease. Sterile syringe and needle included. Cannot ship outside the U.S. To ensure the product arrives chilled, we strongly recommend selecting UPS 2 Day Air or UPS Next Day Air shipping.

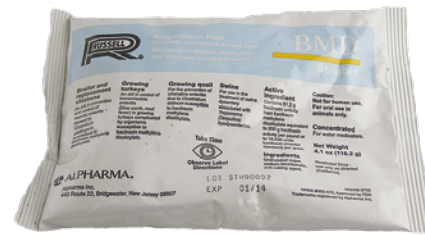

Treats & prevents enteritis

Bacitracin Soluble

PH224

\$32.50

Treats and prevents enteritis in chickens (up to 16 weeks of age), quail and turkeys.



For your flock's gut health

Zyfund® A Chicken Dewormer 30 ml

PH207

\$15.75

Proprietary, all-natural supplement for use during feed changes, stressful times, environmental changes or other events to help maintain normal digestive health. Keeps intestinal parasites away and safe for organic-certified flock management.



RopaPoultry Complete Oregano Oil+ Supplement - 500 ml

PH243

\$36.75

100% natural essential oil ingredients with antifungal, antiviral, and antibacterial agents to improve flock health so they can produce high-quality eggs and great quality meat.



Add OregaPro to your health aids!

OregaPro is the perfect addition to your water mixture to help keep your flock happy and healthy! OregaPro is specially created to boost your birds' immune system and is even helpful in times of stress!

Check out OregaPro and the Wonder line starting on page 36!

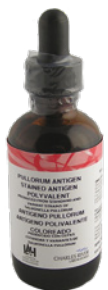

Detects pullorum disease & fowl typhoid

Pullorum Antigen

PH359	350 tests - 14 ml	\$136.50
PH360	1,000 tests - 40 ml	\$267.50
PH241	Blood Testing Instrument	\$11.95

This will bring out reactors in fowl that carry Salmonella Pullorum. Testing is required for poultry shows. This antigen is a suspension of five killed, stained strains of Salmonella pullorum for the detection of pullorum disease and fowl typhoid in poultry flocks. Cannot ship outside the U.S. Stromberg's recommends choosing UPS 2 Day Air or UPS Next Day Air shipping to ensure this product arrives chilled.



Vetericyn Plus Utility Spray 16 oz

PH199 **\$32.95**

Vetericyn Plus Utility Spray is an all-purpose wound cleansing care solution for livestock application. Vetericyn Plus Utility Spray is a one-step liquid solution for cleaning, irrigating, debriding and moisturizing wounds, lacerations, abscesses and sores. You can also use it on any sensitive areas that commonly become irritated. This product contains no antibiotics or steroids and will not sting or burn. This product requires no withdrawal time for meat or eggs.



Pick-No-More Cover Up Poultry Lotion 4 oz

HP225 **\$10.95**

Controls cannibalism in poultry. Comes in a convenient squeeze bottle with applicator tip. All natural ingredients deter birds from picking. For external use on poultry and game birds.



Sanitizes water lines, prevents blackhead

Acidified Copper Sulfate 16 oz

PH317 **\$15.95**

Use to reduce algae in water lines and as a copper supplement in feed. Prevents and treats blackhead (histomoniasis) in turkeys and canker (trichomonosis) in chickens. A source of supplemental copper for chickens and turkeys. Can also reduce stress and picking of feathers.



Blu-Kote Germicidal Fungicidal

PH200 **\$10.50**

A quick-to-dry wound antiseptic and fungicide for horses and dogs. Can also be used as a treatment for bumblefoot in chickens and prevents group pecking. Available in convenient aerosol spray. 128 grams.



Prozap® Garden & Poultry Dust 2 lb

PH227 **\$10.95**

Controls the northern fowl mite, chicken mites, lice, and bedbugs, all of which can be found on the bird or in poultry houses. Can be used on all type of fowl. Apply to birds directly or on bedding. One pound of the dust treats 100 birds.



Permethrin SFR Termiticide/ Insecticide

DC835	Pint (473 ml)	\$39.95
DC840	Quart (946 ml)	\$79.95

Permethrin SFR is a ground drench used to control ants and beetles. Mix 1 fl. oz per gallon of water. Permethrin SFR creates a strong insecticidal barrier that is safe to use around pets and livestock.



Diatomaceous Earth

DE376	5 lbs	\$19.95
DE375	50 lbs	\$79.95

Diatomaceous earth is a mineral-based substance made from the fossilized remains of algae-like water plants. Diatomaceous earth is a 100 percent natural product with numerous uses. Keep your chickens safe and their food supplies fresh using diatomaceous earth from Stromberg's Chickens.



Breeding Saddles for Hens

PH451	Paisley Pink - Bantam Size	\$3.95
PH456	Paisley Pink - Chicken Size	\$4.95
PH450	Blue Pattern - Bantam Size	\$3.95
PH455	Blue Pattern - Chicken Size	\$4.95

Protect your hens from getting their feathers plucked with this solution. Your birds will strut in style. Available in Paisley Pink or Blue Pattern varieties.

Livestock & Flock Health



Corid 9.6% Oral Solution Coccidiostat for Calves

PH316

\$26.50

Use water soluble corid to prevent or treat an outbreak of coccidiosis in calves. This easy to use treatment has been in use for years by customers who want the ease of a liquid treatment. Active ingredient: Amprolium



Safe-Guard Dewormer for Goats (Suspension 10%)

PH315

\$31.50

Safe-Guard Dewormer for Goats (10% Suspension) is an oral drench used for the aid in control and removal of stomach worms for goats. 6 day slaughter withdrawal. Active ingredient: Fenbendazole



Ivermectin Topical Solution Pour-On for Cattle 250 mL

PH319

\$26.25

Effective control of these parasites: roundworm, lungworms, cattle grubs, mites, lice and horn flies. Controls biting lice for up to 56 days and horn flies for 28 days. These products are only suitable for animals and are clearly labeled as such.

Ivermectin is not approved by the FDA for the treatment of any viral infection.



Coccidiosis treatment and prevention

Amprol 128 20% Soluble Powder 10 oz

PH233

\$21.00

Water-soluble treatment intended for the treatment of coccidiosis in growing chickens, turkeys and laying hens. Used as a preventative tool or to treat birds that are infected. Also treats swine dysentery associated with Brachyspira hyodysenteriae infection.



Chlorhexidine 2% Solution 1 Gallon

PH318

\$17.00

Use on horses and dogs for superficial cuts, abrasions and insect stings. Provides a wide range of antiseptic and antimicrobial protection against skin bacteria, fungi, ringworm and yeast.

Learn how to treat any poultry disease!



The Chicken Health Handbook

BM709

\$20.95

A must-have for chicken keepers! Your complete guide to maximizing flock health and dealing with disease!

Pigeon Medication & Supplies

Pigeon medications and supplies are designed for pet birds and pigeons. Medications on this page are not for use in livestock intended for consumption.



Tylosin 100g

PH900

\$54.95

Aid in the treatment of chronic respiratory disease (CRD) caused by Mycoplasma. Unable to ship outside of the US.



Wormer Deluxe Powder 100g

PH904

\$34.95

Wormer Deluxe Powder is a comprehensive water-soluble wormer that treats Roundworm, Hook Worm, Caecal Worm, Tapeworm, and Thread Worm. Active Ingredients: 10% Oxfendazole, 10% Praziquantel. Dosage: 1 teaspoon (5 grams) per gallon of water for 2 consecutive days. Repeat treatment in 21 days. Change water daily. Makes 20 gallons of water.



4-in-1 Powder 100g

PH901

\$36.50

Four-in-one powder for paratyphoid, canker, coccidiosis and especially *E. coli*.



Pigeon Bob Trap

TL127 12" x 18"

\$28.95

TL129 12" x 12"

\$24.95

Exercise your pigeons and keep them controlled. The only means of releasing your pigeons for free flight and confining them on their return. Heavy-duty 3/16" aluminum bob rods are stiff enough to prevent crowding or pushing through. Wire lifter locks trap door open when needed. Wooden frame. Easy to install.



Pigeon Nest Bowls

PC244 Blue

\$3.75

PC245 Brown

\$6.50

PC226 White (Sugar Cane Fiber)

\$1.25

This great space saving designed nest is perfect for smaller birds. These bowls provide a safe resting area for your birds. Made to mimic what a mother would use in the wild.



Heavy-Duty Plastic Pigeon Waterers

PW150 Quart

\$7.95

PW271 3 Quart

\$10.95

PW272 2.5 Gallon

\$13.75

This convenient design helps prevent pigeons from dirtying their water.

Stromberg's **ELECTRIC FENCING GUIDE**

Protect your flock and give them the freedom to thrive with our extensive range of electric fencing. Designed to keep predators out, our fencing solutions ensure a safe and secure environment for your birds. Choose the perfect option tailored to your needs and enjoy peace of mind knowing your flock is protected.

IS ELECTRIC FENCING RIGHT FOR YOU?

This flexible electric fencing solution is perfect if you:

- Need a flexible power source
- Need temporary/movable fencing
- Minimal weed contact on fencing
- Want a safer option for your livestock

IS POLY ELECTRIC FENCING RIGHT FOR YOU?

This semi-permanent electric fencing solution is perfect if you:

- Want to deter predators
- Need to fence off a larger area or property
- Want a little flexibility to move
- Need fencing installed quickly

Whichever fencing solution you choose, do not forget the energizer and your necessary fencing accessories!

STROMBERG'S QUALITY: STRONGER THAN THE COMPETITION!

Our fence posts are top-notch! Check out the comparison of our fencing posts versus the competition. Support your fencing with strong, durable posts to keep your flock safe from predators!



Protect More, Easily!

- Poultry
- Livestock
- Bee Hives
- Gardens
- Yards
- Fruit Trees

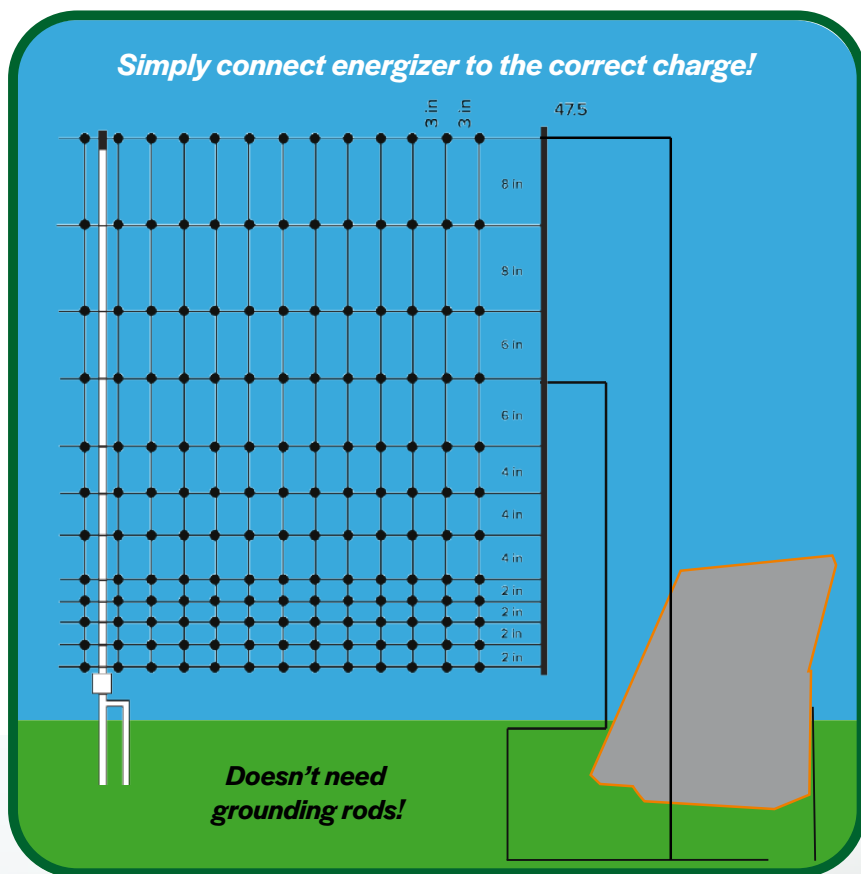

Electric Fencing

PC735 Electric Fence 164 ft **\$249.95**
 PC734 Electric Fence 82 ft **\$149.95**

Just add the energizer! This easy-to-install fencing solution is sturdy and portable! Protect your birds and livestock with this 48" high electric netting.

Electric Positive/Negative Fencing

PC740 48" Tall 164 Ft Long **\$190.65**

Just add the energizer! This easy-to-install fencing solution is reliable in areas with dryer soil! This special design helps prevent sagging between posts. The posts include double spike step-in posts for an extra sturdy hold in the soil!

Pairs well with Solar Energizers!

Upgrade to Positive/Negative fencing for reliability for all soil moisture conditions!





Temporary Electric Fencing Supplies



Electric Fencing Gate

PC730 Poultry Gate

\$100.95

Poultry gate kit includes net gate, drivable posts, handle, and docking station. Allows for quick access in and out of electric fenced area without turning off the energizer.



Corner Post

PC731

\$8.95

Place this post at every corner or curve for extra stability

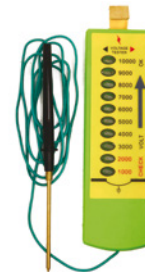

Electric Fence Tester

HD445

\$13.75

Get an accurate read on your electric fencing every time! 10 indicator bulb: 1000V-10000V

*Clean fencing (no green weeds or shorts). A typical fence has weeds that draw power, reducing the miles rating. All Gallagher chargers come with a "miles" rating to help you decide which charger will be ideal for your length of fence. The longer your fence line, the bigger charger you will need to maintain 7,000 volts along the entire length. If you have 3 miles of fence line with 4 lines of poly wire, you actually have 12 miles of fencing material to be powered.

5 mi
30 acres



Gallagher Solar Energizer S40
HD451 **\$359.95**

Distance: Typical Fence: 5 mi/30 ac
Power Source: Solar
Energy: Stored 0.4Joules
Output 0.26Joules
You'll Love: Quick to install, water resistant case, and 360 mounting

14 mi
90 acres



Gallagher Solar Energizer S200
HD452 **\$849.95**

Distance: Typical Fence: 14 mi/90 ac
Power Source: Solar
Energy : Stored 2Joules
You'll Love: Portable and quick to install, water resistant case and battery status indicator

11 mi
60 acres



Gallagher Energizer Battery & Power Adapter
HD455 **\$239.95**

Distance: Typical Fence: 11 mi/60 ac
Power Source: Battery/ 110V Plug in
Energy : Stored 1.16Joules
You'll Love: Easy battery check, Superior fence performance, reliable animal control with built in protection
Battery not included

6 mi
30 acres

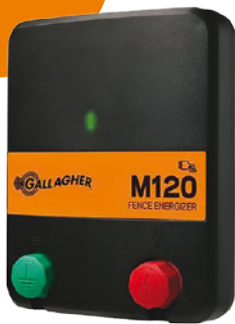

Gallagher Energizer M120
HD450 **\$149.95**

Distance: Typical Fence: 6 mi/30 ac
Power Source: Mains
Energy : Output 0.84Joules
You'll Love: Easy to use and install, tough outer casing and built in lighting diverter, hassle free mounting

30 mi
100 acres



Parmak Magnum Solar-Pak 12
HD351 **\$329.95**

Distance: 30 mi 100 acres
Joules Low: 1.1 High: 3.1+
Power Source:12V Solar/Battery
12 Volt Battery HD353 **\$79.95**
You'll Love: Performance meter, state-of-the art solar panel, weatherproof, portable outdoor

30 mi
100 acres



Parmak Magnum 12
HD352 **\$129.95**

Distance: 30 mi 100 acres
Joules Low: 1.1 High: 3.1+
Power Source:12V Battery (not included)
You'll Love: Performance meter, weather proof, portable, ideal for livestock or predator control



Poly Electric Fencing Solutions



Poly Wire Fencing 656 ft
FM260 1/2" Yellow & Black **\$26.95**

This poly wire fencing is easy to install! Protect your birds and livestock with this sturdy and portable fencing! Made with stainless steel wire, this fencing is durable and made to last!



Electric Fencing Insulators 32 pk
PP398 3" Insulators **\$20.95**
PP399 6" Insulators **\$20.95**

These fencing insulators are made to last! Durable design that is weather and UV resistant. Made for use on either side of the T posts.



T Post Driver
FM205 31.5 **\$43.95**

This heavy-duty weighted steel driver is the best tool for breaking your post through hard soil.



Poly Electric Fencing Made Easy!



Poly Tape Fencing 656 ft

FM270 1/2" Green & Black **\$19.95**
FM280 1/2" Yellow & Black **\$19.95**

This poly tape fencing is easy to install! Protect your birds and livestock with this sturdy and portable fencing! Thicker than the poly wire, this predator-proof barrier can be built to the size you need!



Electric Fence Reel

FM210 **\$49.95**

This durable and light reel makes installing poly tape or poly wire fencing a breeze!



Step-In Fence Post

FM271 **\$5.25**

With this easy, step-in installation, there is no extra equipment needed to get the job done!

Your First Chicken Coop

Getting your first chicken coop is a rewarding process. Set-up for success with a Your First Chicken Coop today!



Your First Chicken Coop

PC196

\$495.95

Introducing the ideal chicken coop to kickstart your poultry hobby! Designed to accommodate five hens comfortably, this coop combines spacious living with the durability of high-quality plastic construction. Its sleek surfaces facilitate effortless cleaning and maintenance, ensuring a hassle-free experience. Featuring dual-sided openings, managing litter removal becomes a breeze. Crafted from UV-protected, BPA-free plastic, the coop assembles seamlessly and guarantees longevity. Security is a top priority with four doors equipped with a reliable locking system.

Your hens will love the convenience of an entrance and exit ramp, a dedicated perch, and a cozy nest for laying eggs. The coop prioritizes ventilation with a rotary system, allowing you to control the airflow. Plus, a clever rainwater collection system ensures a fresh water supply for your feathered friends.

To guide your hens, we've included a plastic egg, making it clear where egg-laying is encouraged. With an emphasis on easy cleaning and simple assembly, this chicken coop promises a delightful and practical experience for both hobbyists and their feathered companions.

Features Include:

- 4 doors with locking system
- Entrance and exit ramp for the hens
- Includes perch
- Nest for the hens to lay their eggs
- Ventilation, with rotary system to choose the level of air intake
- Pipe with a bucket to collect rainwater. This is used for the hens to drink water
- Includes one plastic egg to help show where your birds should lay
- Easy to clean
- Easy assembly

Your First Chicken Coop Features:



Pipe with bucket to collect rainwater - a great source of water for your hens!

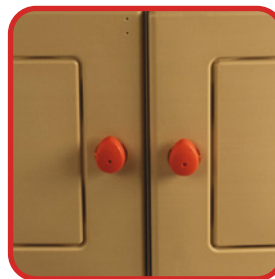

4 doors with locking system for added predator protection



Ramp provides your hens will easy access to the coop



Perch and nesting box for hens inside coop



Coop features adorable details and durable designs

Coops & Pens

Give your birds a dream house that offers protection from predators and the elements!



"The Egg Hut" Wooden Chicken Coop (up to 3 chickens)

PC115 **\$262.50**

The Egg Hut is a beautiful coop with a sturdy design made of fir wood. Egg collecting is made easy by the convenient accessibility to the nest box. The window allows circulation of air through the coop. Portable and easy to assemble. Measures 76" L x 28.7" W x 44.5" H.

*While supplies last**



"Cluck Hut" Wooden Chicken Coop (3-5 chickens)

PC108 **\$367.50**

This sturdy design holds up to 5 chickens easily. Built with fir wood, it is functional yet complimentary to any home or garden. The two easily accessible nest boxes give your birds space to roost and make egg collecting a breeze. Comes with a pull out cleaning tray for quick coop maintenance. Stands 63" X 35.5" X 44.5". Assembly required.

*While supplies last**



"Hen House" Wooden Chicken Coop with Run (2-3 chickens)

PC105 **\$262.50**

The Hen House is made of durable fir wood. The waterproof roof on both the coop and nesting box keeps your chickens dry while the window allows for ventilation. Comes with a pull-out cleaning tray for quick coop maintenance. Portable and easy to assemble. Measures 78.3" L x 28.7" W x 51.2" H.

*While supplies last**



Galvanized Walk In Chicken Run with Roof

PC116	6.6 ft x 9.8 ft x 6.6 ft	\$577.50
PC117	13.1 ft x 9.8 ft x 6.6 ft	\$647.95
PC118	19.7 ft x 9.8 ft x 6.6 ft	\$697.95

These walk-in runs allow easy access to your birds while keeping them safe. You no longer have to duck or crawl into the run to feed or check your birds. They are easy to assemble and come in three convenient sizes that will work in any yard. Place your coop inside and use it as a stationary run or keep your meat birds safe as you move it around the yard. Also comes with a high-quality tarp to provide shade for your birds. Made of galvanized steel and PVC coated chicken wire to last for years to come. PC116 pictured. Tarp does not cover the whole top of run on PC117 and PC118. *While supplies last**

DIY Coops with Building Plans

If you're the DIY type, this the perfect hybrid to build your perfect coop. The plans are made for a coop that is aesthetically pleasing, not too big or too small, easy to clean, can hang heat lamps, and not complicated to build. Some building experience is recommended. Purchase online to receive your digital download.

Included in each plan:

- Digital Instructions
- Material List
- Tool List
- 3D Illustrations

You can build these!

**16-24
Chickens**



**6' x 8' Comfy Coop Large Digital Building Plans
(16-24 Chickens)**

DD6X8

\$26.25

**12-18
Chickens**



**6' x 6' Comfy Coop Large Digital Building Plans
(12-18 Chickens)**

DD6X6

\$26.25

**8-12
Chickens**



**4' x 6' Comfy Coop Large Digital Building Plans
(8-12 Chickens)**

DD4X6

\$26.25

**5-8
Chickens**



**4' x 4' Comfy Coop Large Digital Building Plans
(5-8 Chickens)**

DD4X4

\$26.25

Automatic Coop Doors

No more running to let your flock out! Upgrade your coop with the automation.



CoopSecure Plus Automatic Chicken Coop Door Opener

PH400

\$163.95

This automatic chicken coop door opener is a must-have for your coop! Easily programmable to open in the morning and close in the evening, saving you time and energy! Anti-pinch function means your chickens cannot be harmed by the door, giving you peace of mind! Runs on your choice of 4 AA batteries or 1 x 6V battery (not included).



ChickSafe Chicken Coop Door Opener

PC400	Eco Opener	\$99.95
PC401	Advance Opener	\$169.95
PC402	Door Kit	\$49.95

These weather-resistant door openers automatically detect if the coop door is opened or closed, so there is no calibrating! With an automatic stop and no mechanical switches, these coop doors are a reliable choice. Takes 4 AA batteries. Batteries not included.

The PC400 Eco Opener operates by using a photo sensor, opening when the sensor detects light. The PC401 Advance Opener uses the same photo sensor but also can be set to open and close at specific times. Both openers work perfectly with the PC402 Door Kit (sold separately).

Keep birds in, keep predators out!



Stromberg's Heavy-Duty Knotted Netting:

- Strong, knotted mesh with flexible construction
- Great longevity - can last 10+ years
- Numerous uses - caging, separation, breeding and harvesting
- Will not rust, rot or mildew
- UV resistant
- Can be used in areas with snow and ice
- Heavy-duty construction - 380 denier 20 ply poly strands

This high quality heavy duty game bird netting is just what you need to contain your game birds. The heavy duty netting is capable of withstanding 85 pounds. It is made with UV resistant polyethylene which is made to last 10 years or more in the field. The netting is knotted, which is known for not getting caught in peepers and pins if you are protecting your birds from cannibalism or pecking. This heavy duty netting is perfect for areas that receive snow. This style of netting can also be used in any poultry area that you may want to protect your birds from aggressive birds of prey. When your chickens matter to you and you can't keep the birds out of the chicken run, this product will be sure to protect them. Use rings and ring clincher (sold separately) to install or simply use the zip ties. Netting is non-returnable once taken out of the original packaging.



Available in two mesh sizes!

1" Mesh Ideal for Quail Flight Pens		
PC520	25' x 25'	\$89.95
PC534	25' x 50'	\$189.95
PC517	25' x 100'	\$359.95
PC519	50' x 50'	\$359.95
PC521	50' x 100'	\$795.95
PC518	25' x 150'	\$359.95
PC522	50' x 150'	\$749.95

2" Mesh Ideal for Pheasant & Chicken Pens		
PC525	25' x 25'	\$54.75
PC523	25' x 50'	\$75.75
PC524	25' x 100'	\$147.00
PC526	50' x 50'	\$169.95
PC527	50' x 100'	\$262.50
PC530	50' x 150'	\$367.50
PC529	100' x 100'	\$499.95
PC528	100' x 150'	\$799.95

Installs easily & lasts over a decade!

Must have fencing...



1" Galvanized & PVC Coated Wire Hex Fencing:

- Constructed of high-strength 20 gauge wire
- Galvanized wire used to prevent rust & corrosion
- Coated in PVC for added durability
- Added weather resistance

Our 1" Galvanized & PVC Coated Wire Hex Fencing is a must have for your game bird flight pen or chicken run. Double the strength and durability with both galvanized wire and PVC coating.

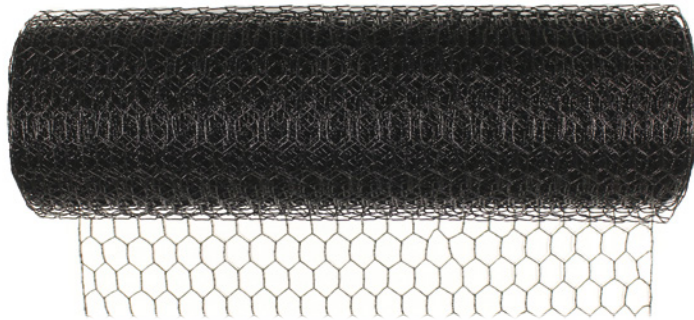

Wire Hex Fencing		
Ideal for Game Bird & Chicken Pens		
PC305	2' x 100'	\$84.00
PC306	3' x 100'	\$105.00
PC307	4' x 100'	\$115.50
PC308	5' x 100'	\$157.50
PC309	6' x 100'	\$220.50

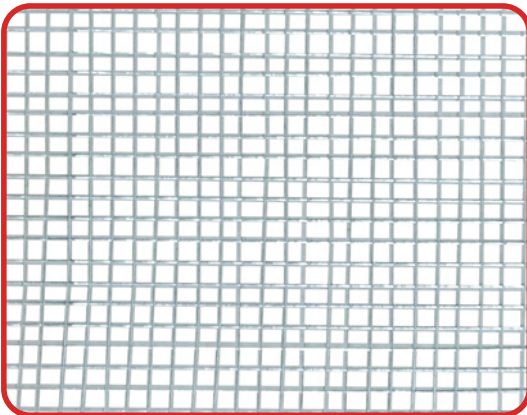

1/2" Galvanized Hardware Cloth:

- Hot dipped galvanized after weld for superior durability
- Constructed from welded steel wire
- Heavyweight 19 gauge design
- Galvanized wire used for rust & corrosion prevention

Our hardware cloth is highly versatile and can be used for creating chicken coops and poultry netting to keep your birds secure. Additionally, this wire mesh is perfect for constructing garden fencing, pest control barriers, and even animal enclosures.

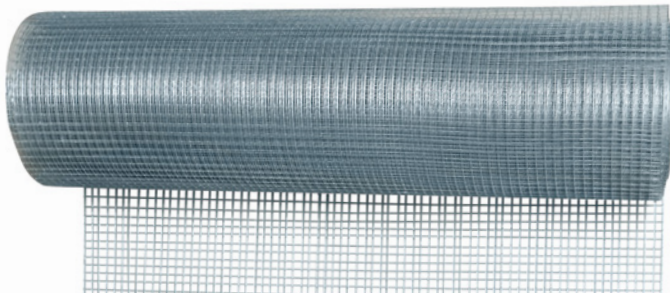

1/2" Hardware Cloth		
Multi-Purpose		
PC301	3' x 50'	\$132.95
PC302	4' x 50'	\$168.95
PC303	5' x 50'	\$220.50
PC304	6' x 50'	\$252.00

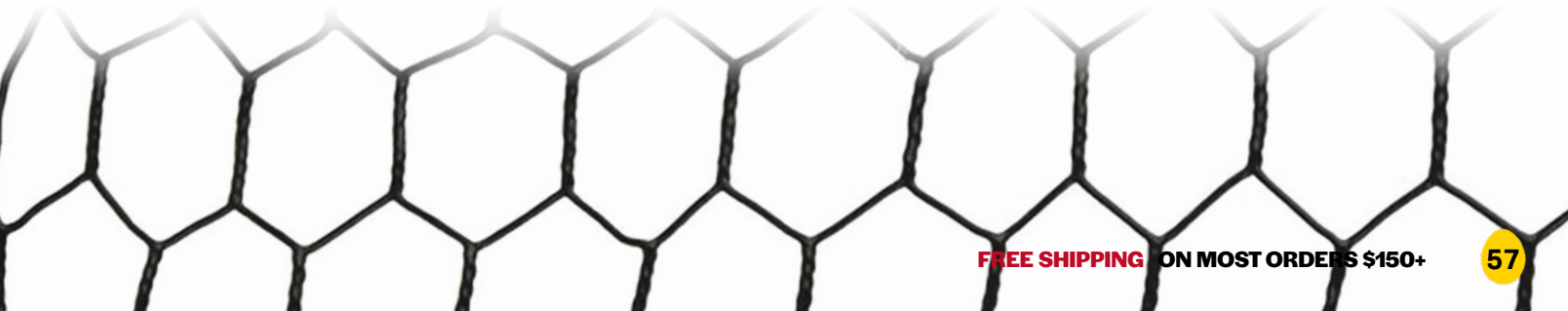

DON'T FORGET THE TOOLS & SUPPLIES

Secure Your Fencing & Netting!

Shop all of our tools and supplies to make sure your fencing and netting is safe and secure!



1/4" Fencing Staples
PC760 1 lb. **\$5.25**



Galvanized Aircraft Cable
PC545 250 ft **\$77.75**
PC546 500 ft **\$114.95**



Lacing Cord
PC540 1000 ft **\$24.25**
Lacing Needle
PC541 8" x 1" **\$2.50**



UV Resistant

8" Black Zip Ties
PP272 25 Pack **\$3.25**
PP282 100 Pack **\$6.95**
PP262 1000 Pack **\$22.25**

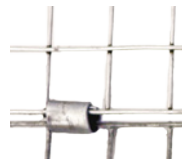

Versatile Metal Clamps
Assembling projects
Repairing projects
Clinch to fasten

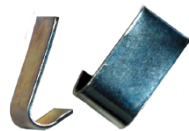

Cage Clamps 500 clamps/lb
PC581
Per lb. **\$7.50**



Clamp Clincher
PP982 **\$8.95**



Heavy Duty Clincher
PP985 **\$17.00**



Cage Clamp Remover
PC582 **\$39.00**



Galvanized Rings
Assembling projects
Repairing projects
Clinch to fasten



Cage Rings 425 clamps/lb
PC550
Per lb. **\$5.25**



Ring Clincher
PP986 **\$10.50**



Economy Ring Clincher
PP984 **\$6.50**



Clincher for Hard to Reach Places
PP981 **\$21.00**



Cage Rings
Streamline the process
Convenient auto feed
Quick and easy



Auto Feed Ring Clincher
PP983 **\$63.00**
PC553 2500 Rings **\$42.00**



Economy Auto Hog Ringer
PB461 **\$12.75**
PP011 Hog Rings (600) **\$2.25**



Flush Out Wire Cutters
PC569 **\$26.95**

Stop Predators & Pests in Their Tracks



Repeating Mouse & Rat Trap

TL130

\$54.95

Tired of all the mice and rats eating your chicken feed? Our repeating mouse and rat trap will continue to catch those pesky rodents without any work. We recommend baiting the trap, but have had excellent results without any bait at all! Use the trap in pole barns, garages, or any place you are worried about mice. It is has proven to be the best mouse trap we have ever tested or marketed. Operates as a live trap.



Nite Guard Solar Animal Repellent

HD364 Nite Guard

\$33.95

HD366 Repellent Tape

\$17.95

Predators react to the red flash of the Nite Guard as they would the eye of another predator and leave the area.



Rat & Mouse Bait Stations

TL112 Mouse Bait Station

\$12.75

TL113 Rat Bait Station

\$18.95

The mouse or rat will eat the poison and return to their nest and perish. The bait station provides a secure spot where pets and children do not have access to the poison. Bait chunks sold separately.



Tomcat Bait Chunx

TL151 All-Weather

\$23.95

TL150 with Bromethalin for Mice and Rats

\$31.50

One-ounce bait block can kill up to 12 mice or 10 rats. The mouse or rat will eat the poison and return to their nest and perish. 4 lb pail



Rodent Traps

TL101 The Better Rodent Trap - 2 pack

\$9.50

TL102 Sure Catch Multiple Catch Mousetrap

\$19.00

Capture mice and rodents easy! No complicated mechanical parts. Just press to set and squeeze to release. No-touch design makes these traps a snap to use. For mice, moles, shrews and other very small animals.

Starplate Building System

Starplates are steel plates, with channels to hold 2x2's, 2x3's,

- **Build a chicken coop in a day!**
- **Versatile DIY project**
- **Strongest structural form**

Scan the QR code to check out an instructional video created by a customer who purchased our kit to make their own greenhouse!

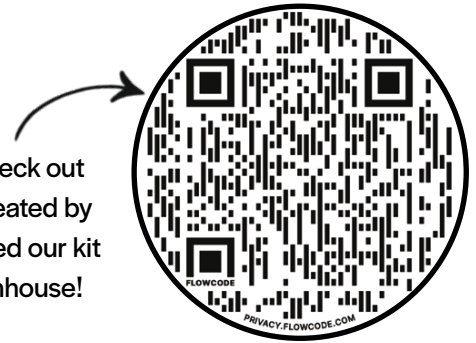

Simply drill holes in each end of 25 struts of equal length and bolt them into the 11 star plates to build a solid, mini-dome framework in under 2 hours!

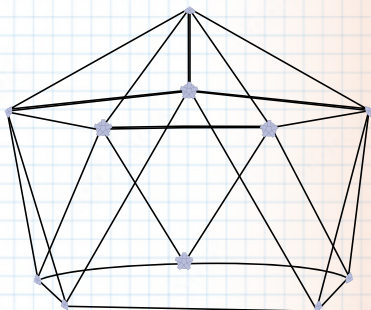

Base Kit

- 11 Starplates
- 50 bolts, 50 washers, 50 nuts
- Starplate instructions
- Starplate lumber cutting templates

PC609

2x4 Kit

\$300.00

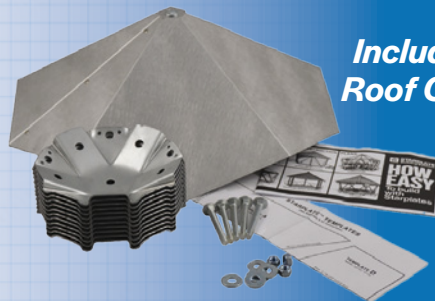
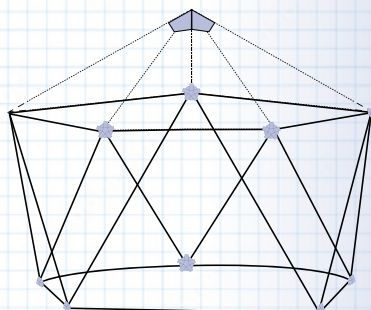

*Includes
Roof Cap!*

Deluxe Kit

- 11 Starplates
- Roof Cap
- 50 bolts, 50 washers, 50 nuts
- Starplate instructions
- Starplate lumber cutting templates

PC613

2x4 Kit

\$350.00

Build almost anything!

Storage Building

Greenhouse

Gazebo

Wood Shed

Corn Crib

Ice Fishing Hut

Vertical Sided Building

Fruit Stand

Compost Container

Hot Tub Enclosure

Small Cabin with Loft

and so much more!

Separates

Roof Cap Only

PC611

8" Roof bolt and tube of silicone

\$49.95

Starplate Connectors Only

PC600

11 starplates, starplate instructions, starplate lumber cutting templates. Does not include bolts

\$280.00

Nesting Boxes

We offer a large selection of chicken nesting boxes for sale in a variety of different styles, sizes and features. Our poultry nest box selection ranges from Conventional Nest Boxes and Roll Out Nest Boxes to Large Bird Roll Out Nest Boxes. Whether you need large or small nest box solutions, we have everything you need.



Stromberg's Front Roll Out Nest Box

PC160 4-Hole	\$320.25
PC161 6-Hole	\$330.00
PC162 8-Hole	\$368.95
PC163 10-Hole	\$441.00

Our conversion 4, 6, 8, and 10-hole nest boxes are a Stromberg's Exclusive! The new design of our galvanized metal nesting boxes allows you to easily convert each individual hole from the rollout feature to conventional whenever the need. It grants the ability to have any number of your nest compartments with the rollout feature preventing your eggs from getting dirty or soiled from your hens. Each nest box has its own individual metal flap for easy collection. Have a broody hen and do not want the roll out feature in one of your nest holes? No worries, remove the roll out nest bottom and install the conventional nest bottom then just securely close the flap with the latch. The plastic perch allow for easy sanitation. It flips up for egg collection and to close off the nest boxes at night if necessary. Includes roll out nest bottoms and 12"x12" conventional nest bottoms. Some assembly required.

Nesting Boxes



My Cozy Nest

PP198 Single **\$33.95**
 PP199 10 Pack **\$315.00**

The Cozy Nest offers the perfect place for your birds to lay their eggs. The black out curtain provides a safe and dark place that your birds will naturally gravitate to for egg laying. The ventilation grills provide the necessary air flow so the birds feel comfortable in the nest but not exposed to drafts. The molded plastic is easy to clean and with the built in lip the birds do not kick the shavings out of the nest. We recommend putting wood shavings or excelsior nest pads in the bottom of the My Cozy Nest.



Best for small flocks!

Galvanized Nesting Box with Plastic Baskets

PC220 Single **\$47.95**
 PC221 Double **\$68.95**
 PC222 Triple **\$121.25**

Have a small flock? Use our one, two, or three hole roll out nest boxes in your coop. The plastic construction allows for easy sanitation when needed. The roll out egg feature keeps eggs cleaner and prevents hens from pecking the eggs.

Collect from the back



Perfect for collecting eggs in aisles

10 Hole Rear Roll Out Nest

DSPC210 **\$599.95**

This nest is designed for those desiring to collect eggs from aisles in between the pens. The nests can be mounted on the wall, the hens enter from the front and the eggs roll out the back. The back is hinged so the collector can push in for inspection, plus the back of the nest is blocked so the hen can't go out. Complete with plastic roll out bottoms. 60" W x 34" H x 12" D. Rivet gun required for assembly, not included. **Ships direct from manufacturer.**

Stromberg's says:

Unlock the benefits of a roll-out nest – a simple yet effective solution that safeguards your eggs and maintains their cleanliness. How does it work? The nest is designed with a gentle incline; as the bird lays an egg, it smoothly rolls down into a protected compartment. This innovative design minimizes the time eggs spend in the nest, ensuring they stay cleaner. Additionally, the roll-out nest shields eggs from the risk of breakage by preventing interference from clumsy or egg-eating hens.



Nesting Pads & Essentials



12" x 12" Turf Nesting Pad

PC254 **\$7.95**

Customer favorite! This is a great new product to come to the nest pad market. These nest pads are made out of high-quality turf grass. American made and have a one-year manufacturer's warranty. This pad is also very easy to clean you can just hose it off let it dry and set it right back into the nest box. These turf nest pads are so soft your birds will love them!



13" x 13" Excelsior Moisture Wicking Nesting Pads

PC258 40 pk **\$59.95**

Excelsior nest pads help to provide cleaner, fresher, better quality and more hatchable eggs. They are economical, easy to place in the laying nests and help in faster egg gathering. The eggs are on top, clean and fresh rather than having to hunt and dig for eggs as with some other products. They also draw moisture from droppings which drop to the paper below, out of the area in which the eggs are laid.



Washable Plastic Nesting Pad

PC219 **\$3.45**

Assures cleaner, better hatching eggs. Resistant to lice, insects, rot, mildew & fungal growth. Allows dirt to pass through the nesting pad. Washes out easily. Sturdy plastic material. 11" x 11.5"



Plastic Roll Out Nest Pad

PC208 **\$8.95**

Specially designed roll-out nest pad for roll-out nest boxes. Material simulates straw and other nest filling materials. Compatible with our 4, 6, 8, or 10 hole nest boxes (pg 61). Fit snugly in the individual holes in each nest box. Made of durable plastic, easy to clean, and helps keep eggs clean.



Plastic Nest Eggs - 6 pk

PP096 Bantam/Pigeon	1	\$5.95
- White	2+	\$3.75
PP099 Chicken - White	1	\$4.50
	2+	\$3.25

Dummy eggs for use in nests to encourage new, first time layers. Sometimes called "fooling eggs"! Sold in packs of 6.



Rubber Nest Eggs 2 pk

PP097 **\$8.95**

Realistic nest eggs made of rubber to encourage your hens to lay eggs inside the nest box. They are unbreakable, durable, and discourage egg eating. Pack of 2.

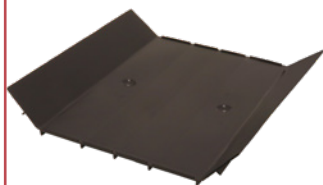

12" x 12" Adjustable Plastic Nest Bottoms

PC214 **\$7.00**

Plastic will not rust, rot or corrode from broken eggs and manure. Features adjustable ends allowing it to fit practically all nests with a 12" front. Has flexible end flaps that are 2.25" to fit the size of any nest. Easy to remove and clean.



Roll Out Nest Bottom Converter

PC209 **\$15.45**

Plastic roll-out nest bottom for replacement or conversion. Unit is made out of heavy-duty plastic material to provide multiple seasons of trouble-free utilization. 12" x 21" x 3"

Stacks Up to the Competition

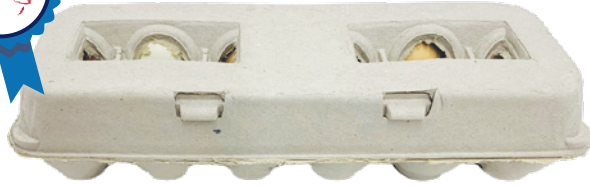

Large Blank Egg Cartons

PP241	125 pack	\$44.95
PP213	250 pack	\$79.95
PP240	Pallet of 4,500	\$1,395.00

Blank paper carton. Fits large eggs. Ready to personalize. Room for stickers, stamps, and more. Eco-friendly, made from recycled materials. Biodegradable.

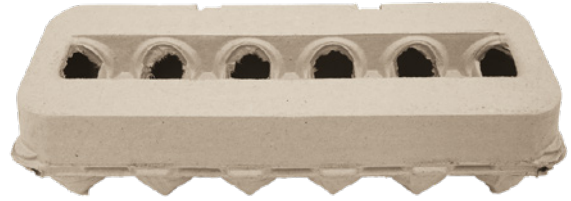

Jumbo Blank Egg Cartons

PP235	100 pack	\$49.95
PP236	200 pack	\$89.95
PP237	Pallet of 3,000	\$1,199.95

Blank paper carton. Fits jumbo eggs. Ready to personalize. Eco-friendly, made from recycled materials. Biodegradable.

Includes nutritional facts for selling



Grade A Large Printed Egg Cartons

PP231	125 pack	\$54.95
PP232	250 pack	\$99.95
PP233	Pallet of 4,500	\$1,299.95

Printed with USDA approved labeling to sell eggs. Eco-friendly, made from recycled materials. Biodegradable.

Includes nutritional facts for selling



Fresh Grade A Jumbo Printed Egg Cartons

PP227	100 pack	\$59.95
PP228	200 pack	\$103.95
PP225	Pallet of 3,000	\$1,299.95

Printed with USDA approved labeling to sell eggs. Eco-friendly, made from recycled materials. Biodegradable.

**Blank space =
Creative space**



Large Blank Flat Top Chicken Egg Cartons

PP243	100 pack	\$59.95
PP244	200 pack	\$109.95
PP245	Pallet of 3,600	\$1,399.95

Large blank top is great for customizing. Eco-friendly, made from recycled materials. Biodegradable.



Printed Large Egg Carton, Farm Fresh

PP265	125 pack	\$74.95
PP266	250 pack	\$136.95
PP267	Pallet of 4,500	\$1,499.95

Stromberg's exclusive and perfect for farmer's markets. Advertise that your eggs are fresh, hand gathered, and come from happy hens! Made from recycled materials. Biodegradable.

Make Transport Easy!

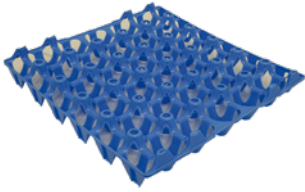

30 Egg Capacity Premium Plastic Egg Flat

PP493

\$2.45

Make egg sorting and sanitizing a breeze! Specially designed for optimal air and water circulation which allow for maximum cleaning and drying. Made from UV stabilized, HDPE virgin material which is non-toxic & non-staining.

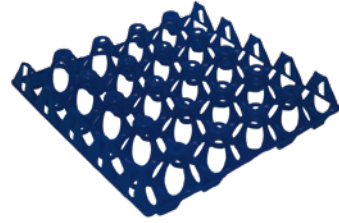

Large Turkey/Duck Egg Tray

PP515

\$2.45

This vented duck egg tray is designed for the washing, sanitizing, and disinfecting of larger eggs. Specially designed openings allow for better circulation of water and air for superior cleaning and drying ability. 20 egg capacity.

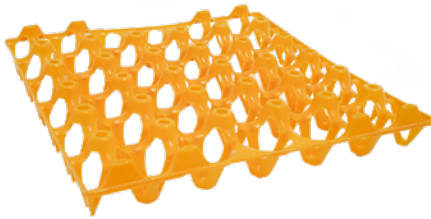

30 Egg Capacity Plastic Jumbo Egg Tray

PP550

\$2.45

Stackable and ready for eggs! Makes cleaning eggs easier and more effective!

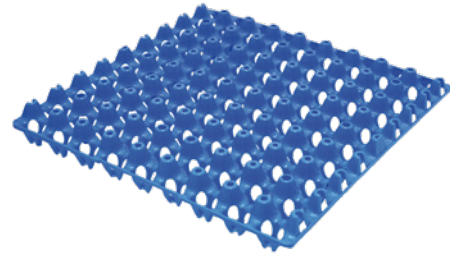

Plastic Quail Egg Tray

PP251

\$2.45

This high-quality, plastic egg tray holds 72 quail eggs. Stackable and will fit standard size egg crates.

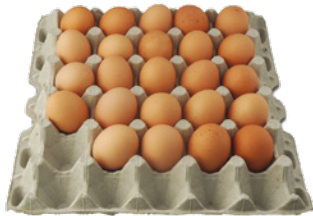

30 Egg Filler Flats

PP528 35 pack

\$19.95

PP529 140 pack

\$63.95

Keeps eggs safe and secure. Fits in transport case. Eco-friendly, made from recycled materials. Biodegradable.



Plastic Quail Egg Cartons (holds 24)

PP218 50 pack

\$34.95

PP217 100 pack

\$60.95

PP223 300 pack

\$239.95

Flat top for labels. Snaps shut.

*While supplies last**



15 Dozen Egg Plastic Crate

PP215

\$42.00

Ideal for commercial and retail use. Universal use for egg trays and flats. Fits 15 dozen eggs, whether in egg cartons or egg flats.



15 Dozen Egg Box (Case of 25)

PP222

\$60.95

Fits 15 dozen eggs, whether in egg cartons or egg flats.

Egg Wash & Supplies



Little Egg Scrubber

PP055	Little Egg Scrubber Machine	\$399.00
PP056	Enzyme Soak	\$32.00

Wash your eggs in less than half the time compared to hand washing. This egg cleaning device will gently and safely scrub a dozen eggs in a minute and over 600 an hour. Place the scrubber in the sink with reservoir, turn on the lukewarm water, plug the scrubber in and place the dirty eggs in the three green pockets. Let your eggs tumble and scrub for 15 seconds. Remove one of the eggs, rinse and dry. This unit is small, lightweight, portable and easy to store. It is 10" W x 6" H and designed to fit the average kitchen sink. **Ships direct from manufacturer.**



Stromberg's Egg Wash Detergent

PP057	5 lb	\$42.00
PP058	45 lb	\$324.95

Cleans eggs quickly and safely. One pound washes 100 dozen eggs. Follow instructions for use.



All Natural Egg Cleanser

PH208	16 oz	\$12.25
PP061	33.9 oz	\$17.50
PP062	Gallon	\$40.00

Safely remove common stains and residues on your eggs with the power of natural enzymes. Ready-to-use. 1 oz washes a dozen eggs.



Carefree Enzymes Egg Wipes 25 Ct

PP064		\$12.50
-------	--	----------------

Plant-based formulation gently cleans the egg of soils after laying. One cloth cleans up to a dozen eggs depending on the soil level. Wipe the egg with the soft biodegradable pop-up cloth. Dry with a clean cloth or paper towel. Store cleaned eggs in the refrigerator. Used cloths can be tossed in the compost bin.

Sell your eggs in style!

Make it egg-stra special with baskets, signs, and specialty egg stamps!

PP007
Yellow
Holds 15 Dozen

PP004
Red
Holds 2 Dozen

PP582
Lime Green
Holds 8 Dozen

PP005
Blue
Holds 3 Dozen

PP006
Red
Holds 5.5 Dozen

Plastic Coated Egg Baskets

PP007	Yellow, Extra Large (holds 15 dozen)	\$23.95
PP582	Lime Green, Large (holds 8 dozen)	\$19.95
PP006	Red, Large (holds 5.5 dozen)	\$19.95
PP005	Blue, Medium (holds 3 dozen)	\$14.95
PP004	Red, Small (holds 2 dozen)	\$10.50

Plastic coated metal egg baskets, will not mark eggs. Basket's shape allows free flow of air for fast cooling and drying.

Eggs for Sale Signs

GF086	Eggs for Sale Yard Sign 24" x 18"	\$11.95
GF085	Yellow Eggs for Sale Yard Sign 11" x 11"	\$4.25
GF229	Metal Yard Stake	\$6.25

Get your marketing materials for successful egg sales! Metal Yard Stake works perfectly with the GF086 Eggs for Sale Yard Sign. Metal Yard Stake is sold separately.

Egg Stamps

GF552	Butt Nugget Stamp	\$2.95
GF553	Laid with Love Stamp	\$2.95
GF554	Free Range Stamp	\$2.95
GF555	Farm Fresh Stamp	\$2.95
GF557	You Crack Me Up	\$2.95
GF558	Hand Gathered	\$2.95
GF559	Chicken Tracks	\$2.95
GF560	Enjoy	\$2.95
GF556	Black Food Grade Ink - 2 oz	\$15.75
GF550	Stamp Pad	\$.95

These adorable stamps will add that little extra to your eggs. Add in our stamp pad and food grade ink for all you need to give your eggs that extra sizzle. Stamps are 2 cm x 2 cm.

*While supplies last**

HOT SCALDERS

Getting the perfect scald on your birds is the key for easy plucking and a smooth running processing system overall. Achieving that perfect scald starts with having a great scalding. At Stromberg's we carry a variety of scalding options that, regardless of the size of your operation, gives you a delicious dressed bird you can be proud of every time.

14.5 & 26 Gallon Scalding Features:

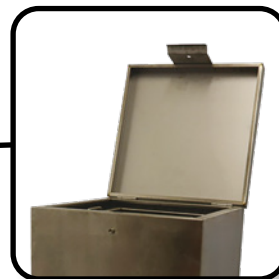

Heats quickly & maintains heat by closing lid

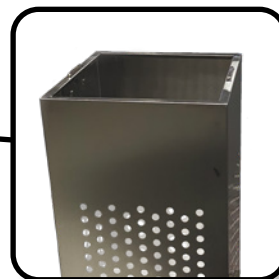

Inner stainless steel basket strains out feathers



Adjust & read the temperature easily



Built-in drain for easy cleaning

Two size options, same great features!

Both Stromberg's 14.5 & 26 Gallon Scalders carry these features, so regardless of the capacity you need, you get a perfect scald every time!
(PP930 - 14.5 Gallon Scalding shown above.)

14.5 Gallon Scalder

PP930

\$367.50

Meet our 14.5 gallon Stainless Steel Poultry Scalder – the ideal solution for small to medium-sized flock owners. Crafted for efficiency, this scalder boasts a dial thermostat for easy temperature control and a built-in lid to aid in heating. Cleanup is a breeze with the user-friendly drain and convenient strainer basket that effortlessly removes feathers and debris. Simplify your poultry processing experience with this durable and efficient Stainless Steel Poultry Scalder – the perfect tool for achieving consistently excellent results.

1 Year Warranty from purchase date

Features:

- Made of 201 Stainless Steel
- 110V cord with plug
- Temperature range – 32° F – 230° F
- Full tank capacity: 14.5 gallons
- Fits 1-2 chickens

Dimensions:

- Outer width: 13.75"
- Basket width: 10"
- Scalder height: 26.5"

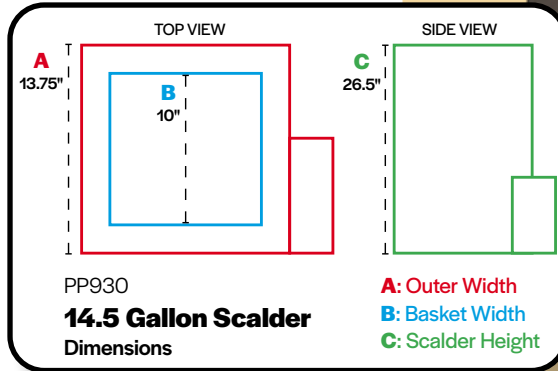

**1-2
Chickens
scalded at a time**



26 Gallon Scalder

PP935

\$525.00

Introducing our 26 gallon Poultry Scalder, perfect for handling larger jobs with ease. Whether you're working with larger birds or processing a larger quantity, this scalder ensures optimal performance. The dial thermostat guarantees precise temperature control for your scalding water, while the user-friendly drain and convenient strainer basket simplify cleanup by effortlessly removing feathers and debris.

The 220-volt heating element ensures a rapid heat-up and quick recovery to the target temperature, making your poultry processing experience efficient and reliable. Upgrade to our 26 Gallon Poultry Scalder for streamlined operations and consistently superior outcomes.

1 Year Warranty from purchase date

Features:

- Made of 201 Stainless Steel
- 220V cord without plug
- Temperature range – 32° F – 230° F
- Full tank capacity: 26 gallons
- Fits 3-4 chickens

Dimensions:

- Outer width: 19.5"
- Basket width: 15.5"
- Scalder height: 25"

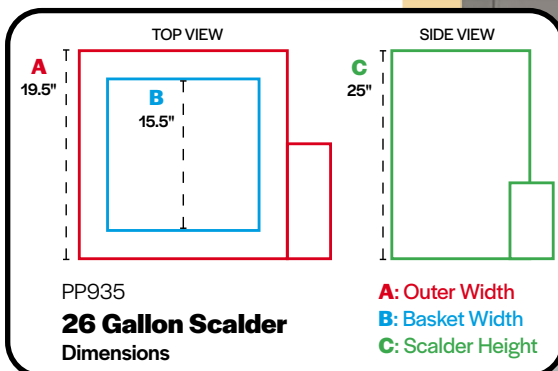

**3-4
Chickens
scalded at a time**



PLUCKED TO PERFECTION



Poultry Plucker - Small

PP760

\$630.00

Features:

- Plucks 1-2 chickens at a time
- 116 plucker fingers
- 550W, 110V cord with plug
- 1400 RPM

1 Year Warranty from purchase date

Dimensions:

- A:** Drum Outer Diameter: 18.5"
- B:** Drum Inner Diameter: 12.5"
- C:** Plucker Depth: 13.5"

Poultry Plucker - Medium

PP765

\$820.00

Features:

- Plucks 3-4 chickens at a time
- 136 plucker fingers
- 1500W, 110V cord with plug
- 1400 RPM

1 Year Warranty from purchase date

Dimensions:

- A:** Drum Outer Diameter: 20.5"
- B:** Drum Inner Diameter: 14.5"
- C:** Plucker Depth: 17"

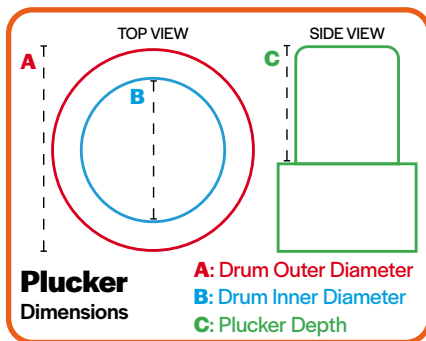

Easy waterproof on/off switch access on the side of the unit

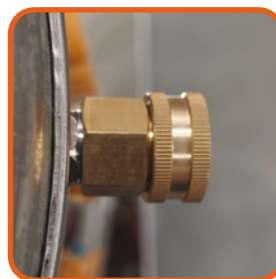

Valve attachment on the side for female garden hose fitting

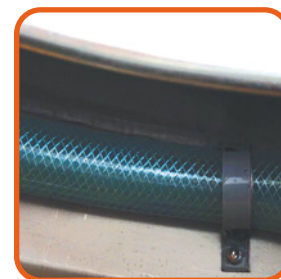

Water inlet and hose inside the drum helps flush feathers

Stainless Steel Pluckers are your solution to fast and easy plucking! Get perfectly plucked birds every single time with these efficient pluckers. Made of stainless steel, these pluckers are easy to transport with 4 caster wheels, including 2 locking ones. They also include vibration absorption to reduce rattling and shaking during the plucking process. Order yours today! These pluckers SHIP FREE* directly from our warehouses!



Poultry Plucker - Large
PP770 **\$945.00**

Features:

- Plucks 5-6 chickens at a time
- 184 plucker fingers
- 1500W, 220V cord without plug
- 1400 RPM

1 Year Warranty from purchase date

Dimensions:

A: Drum Outer Diameter: 25"
B: Drum Inner Diameter: 16"
C: Plucker Depth: 17.5"

Poultry Plucker - X-Large
PP775 **\$1495.00**

Features:

- Plucks 7-10 chickens at a time
- 211 plucker fingers
- 2200W, 220V cord without plug
- 1400 RPM

1 Year Warranty from purchase date

Dimensions:

A: Drum Outer Diameter: 31"
B: Drum Inner Diameter: 18.5"
C: Plucker Depth: 17"



Natural rubber fingers with a hardness of 50-55

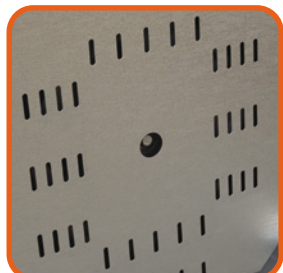

Waterproof plate on bottom of plucker ensures durability



Heavy-duty caster wheels add mobility and include 2-wheel lock system



Scan for a video run-down on these pluckers features!

*Free shipping is subject to our shipping policies. Please see page 146 for details.

FREE SHIPPING ON MOST ORDERS \$150+

Process Your Bird Like A Pro!

STEP 1: SCALD

Scalding your poultry is the key to successfully processing your chickens, turkeys, and game birds. It loosens feather quills for easy plucking. Stromberg's Professional Poultry Scalding ensures your birds are heated to the ideal temperature for an overall smoother plucking process.



Features built-in precision digital temp control



Removable strainer basket for after scald bird removal



Professional Poultry Scalding

PP928

\$2178.95

Features:

- 29 Gallons, scalds 1-3 Chickens at a time
- Made from 304, heavy-duty, 12 gauge stainless steel
- Strainer basket for quick cleaning
- Durable casters for easy movement
- 220 V/19 amp, 4000 W
- 1 Year Warranty from purchase date

Dimensions:

- A:** Outer Diameter: 25.5"
- B:** Basket Diameter: 18.5"
- C:** Unit Height: 24"

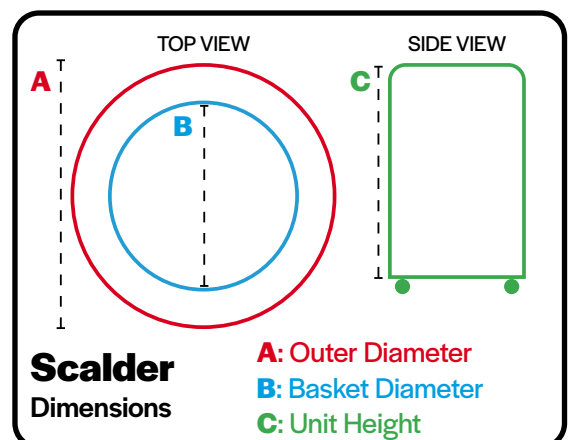

Scald & Pluck Your Birds With the Best!

STEP 2: PLUCK

Plucking your chickens, turkeys, and game birds has never been easier with Stromberg's Professional Poultry Plucker! It easily removes annoying and difficult pin feathers often overlooked by less powerful machines,



Easy-to-use on/off switch and plucker button



Drum has 196 plucker fingers for max efficiency



Professional Poultry Plucker

PP750

\$2729.95

Features:

- 196 plucker fingers pluck 4-5 chickens at a time
- Waterproof switch
- 4 x Durable casters with locks
- Internal water hose to flush feathers
- 2HP motor | 220 V/12 amp
- 1 Year Warranty from purchase date

Dimensions:

- A:** Drum Outer Diameter: 25.5"
- B:** Drum Inner Diameter: 18.5"
- C:** Unit Height: 34"

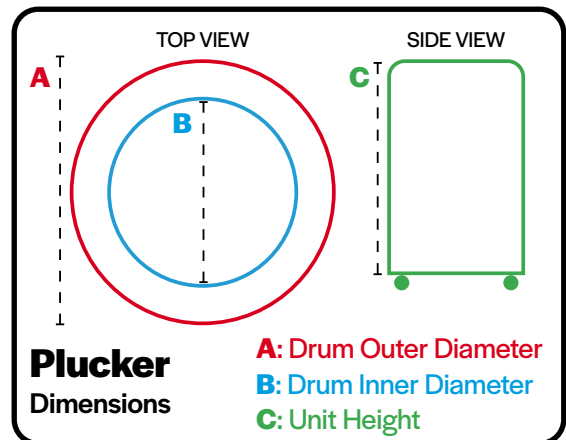

Processing

We have the right equipment for the job! Get everything you need to take your birds from farm to table!



Plastic Fish & Game Cleaning Table

PP944

\$70.95

This folding table is ideal for quick setup and easy storage. Constructed of durable low-molded poly, features a stainless steel faucet that can be connected to a garden hose. The faucet can be removed for easier storage. The table also features a tapered channel for water drainage, drain hose, and a built in ruler located on top of the table. For quick and easy storage, simply fold the legs and disconnect the faucet. Can also be used as a potting table, for cleaning fish or game, or brought along while camping or tailgating. 150 lb. load capacity 44 in. long by 23.5 in. wide by 37 in. high and weighs 23 lbs. 1-year limited warranty.



30 Qt. Poultry Fryer/Scalder Kit

PP836 Fryer/Scalder Kit

PP838 10 qt Fry Pot/Strainer Add-on

\$61.95
\$29.95

Fry your poultry or scald your birds with ease using just one piece of equipment. This unit has a sturdy steel base with a powerful 54,000 BTU burner and a wind guard to ensure a strong flame and even cooking. The 30-quart aluminum stock pot has the capacity to fit a large turkey. The kit also includes a poultry rack, 12" probe thermometer, lift hook, and a 1 oz injector. Don't forget to purchase the additional 10 qt. Fry Pot/Strainer for perfect fried fish every time!



Easily remove duck pin feathers with wax!

Reusable Poultry Wax 10 lb

PP920

\$51.95

1 lb per 4 ducks. Use for dressing turkeys, chickens, geese and game birds. Most of the wax may be recovered and can be reused. Improves appearance and removes pin feathers with ease!

Processing Essentials

Don't get caught without the right equipment. Our processing tools help keep you safe while humanely processing your harvest.



Cutting Glove

Sizes S-XL (CL172-CL175) **\$17.00**
No longer worry about cutting your fingers while culling your birds. These lightweight gloves will keep your fingers and hands safe while using your sharp knife.



5" Boning Knife

PP840 **\$12.75**
A must for poultry processing and in the kitchen. This knife is for removing the bones of your fowl carcass, evisceration and as an all-around multipurpose butchering knife. It has a 5" high-carbon steel blade and a slip-resistant polypropylene handle.



NSF Certified Sticking Knife

PP847 **\$15.95**
This NSF Certified Sticking Knife has a narrow blade knife and is used to stick poultry and general evisceration. The 3" blade is made out of high-carbon steel and the polypropylene handle is textured to ensure being slip-resistant.



Pinning Knife

PP841 **\$13.95**
Helps remove those stubborn pin feathers. Use this knife to scrape the pin feathers out of the bird. The blade is 2.5" long and made out of high-carbon steel. The handle is a textured, slip resistant polypropylene.



Skinning Knife

PP844 **\$31.50**
This is a curved skinning knife that is especially useful when "parting out chicken", meaning separating legs, wings breasts etc.



9" Heavy Duty Shears

PP855 **\$52.50**
9" Heavy Duty Shears used for poultry processing.



Gizzard Scissors

PP848 **\$66.25**
Made of hot forged, thru-hardened, fully double-plated chrome over nickel, this poultry shear is great for poultry and food processing. High leverage with multipurpose use. Made in Italy. **While supplies last!**



Lung Remover

PP851 **\$14.95**
Save time and reduce fatigue with this great tool. Reduces the pain and fatigue on your fingertips from manually scraping the lungs out of birds. Makes processing faster by using the right tool for the job!



Claus Poultry Shear

PP849 **\$55.95**
These specially designed shears are curved to the right to help you when you are processing your poultry. It is really useful when it comes time to cut the heart and liver. They are made out of a cutlery grade steel that is double-plated with chrome over nickel to protect against rust and stains. **Discontinued - available while supplies last!**



Knife Sharpener

PP846 **\$33.95**
This knife sharpener is a must for every poultry butchering tool kit. Having sharp knives makes the job easier and safer! Blue diamond stones sharpen and hone creating a new edge. White ceramic stones polishes the edge. Safe and easy to use

Restraining Cones

Restraining cones are an essential tool for humane and efficient bird processing. They securely hold the bird in place, minimizing stress and movement during processing, which ensures safety for both the handler and the animal. By preventing excessive movement, restraining cones help achieve cleaner cuts and improve the overall quality of the processing outcome. Durable and easy to clean, these cones are designed for repeated use, making them a reliable and valuable addition to any processing setup.



**Fits 4-14
cones!**

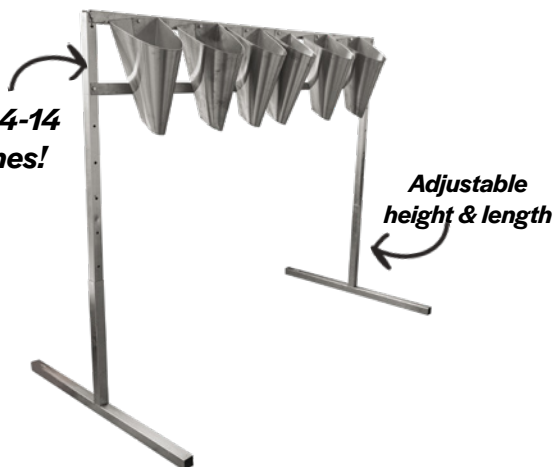

Adjustable Restraining Cone Stand

PP980	Adjustable Restraining Cone Stand	\$327.95
HD730	Shallow Catch Pan	\$27.95
HD732	Deep Catch Pan	\$56.95

Adjust your processing to fit your needs and comfort. Features adjustable height and length, which means you can fit between 4-14 cones depending on the cone size! Has a zinc finish so it will last for years. 48" W x 71 1/4" H. Cones sold separately. Don't forget to add a catch pan for easy cleanup!



Stainless Steel Poultry Restraining Cones

PP570	Small, Pigeons & Game Birds (9"x7"x3")	\$24.95
PP572	Large, Geese & Small Turkeys (13"x12"x5")	\$29.95
PP573	Extra Large (17"x15"x6")	\$34.95
PP574	XX Large (23"x20"x6")	\$39.95

These quality-constructed stainless-steel restraining cones (also known as killing cones) are made from 18-20 gauge stainless steel. These make restraining birds for slaughter easier.

*While supplies last**

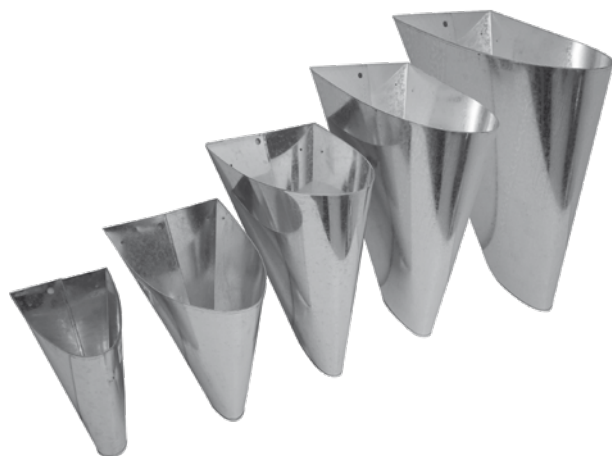

Economy Poultry Processing Cones

PP948	Small - 7 7/8" W, 11" L - Game Birds	\$14.95
PP949	Medium - 9" W, 12" L - Ducks & Chickens	\$19.95
PP270	Large - 10" W, 18" L - Broilers, Geese & Small Turkey	\$27.95
PP950	XLarge - 12" W, 20" L - Turkey & Geese	\$36.75
PP271	XXLarge - 16 1/2" W, 26 1/2" L - X Large Turkey & Large Birds	\$57.95

Economy restraining cone, also known as a killing cone, offers the same convenience but at a lower price.

Seal in Freshness

Saving the rewards of all your hard work is the most important step! Seal your processed birds properly for freshness and flavor that lasts!



85 Microns Thick

Poultry Heat Shrink Bags, 85 Micron (3.4 Mil), 10" x 18"

Experience the superior quality of our 85 Micron Thick Broiler Heat Shrink Bags! Unlike any other poultry heat shrink bag on the market, our bags are thicker, providing unbeatable protection and minimizing the risk of freezer burn. Designed specifically for 2-10 pound meat birds, these bags are the perfect solution for all your packaging needs. With dimensions of 10" X 18", they offer ample space to accommodate your bird. Rest assured, our bags are made from BPA Free plastic, ensuring the safety of your food. Choose our top-notch heat shrink bags for unmatched quality and peace of mind.

PP978 100 pack	\$38.95
PP979 1000 pack	\$319.95

Poultry Heat Shrink Bags, 85 Micron (3.4 Mil), 10" x 18" with Poultry Processing Labels and Zip Ties

PP989 100 pack	\$47.95
----------------	----------------



Heat Shrink Bags with Rounded Bottom

Our heat shrink bags are the perfect addition to your processing operation and add a level of professionalism and ease to your poultry operation. Designed to create a vacuum that seals in freshness and prevents freezer burn, these bags are a must have for any meat producer! Available in three sizes and quantities.



65 Microns Thick

Large Turkey 18" x 32"

PP977 25 pack	\$31.50
PP874 100 pack	\$98.95
PP875 1000 pack	\$814.95

Small Turkey 14" x 24"

PP975 25 pack	\$16.95
PP872 100 pack	\$54.95
PP873 1000 pack	\$489.95

Check out the graphic below for details on how to use our heat shrink bags!



Professional Fit Curved Base

EASY-TO-USE & PROFESSIONAL

HEAT SHRINK FOR THE PERFECT FIT!

- Seals in Freshness and Prevents Freezer Burn!
- Professional Look, Curved for Perfect Fit!
- Meets FDA Standards, BPA/BPS Free, Certified Kosher!



FDA APPROVED
MEETS FDA STANDARDS
CERTIFIED KOSHER



65 MICRON THICKNESS
PREVENTS POTENTIAL RIPS & FREEZER BURN



BPA & BPO FREE
FOOD GRADE PLASTIC



PROFESSIONAL QUALITY
SEALED IN FRESHNESS



PLACE BIRD IN BAG.
REMOVE AIR.



TIE OFF WITH HOG RINGS
OR ZIP TIES & SPIN.
CUT SMALL SLIT



PLACE IN WATER
2-3 SECONDS



180°F



ADD LABEL
& FREEZE

FRESH STORED CHICKEN, MADE SIMPLE



Weston Pro-2600 Vacuum Sealer

PP896	Vacuum Sealer	\$472.50
PP822	Roll Bags 8" w x 50' l	\$11.95
PP820	Roll Bags 12" w x 50' l	\$12.75
PP821	Roll Bags 15" w x 50' l	\$14.75
PP825	50pk Bags 9" w x 12" l	\$11.95
PP824	50pk Bags 12" w x 6" l	\$17.00
PP823	50pk Bags 15" w x 18" l	\$23.25

Seal your birds with ease with the Pro-2600. The powerful, double piston pump seal bar finishes the job in half the time of the competition. With its 935 W of power, these are the most powerful out of chamber vacuum sealers on the market. The clear lid offers the convenience of easier bag alignment and the monitoring of the sealing process. It also has stainless steel housing, fan cooled motor, extra-long 15 inch seal bar, and LED light monitor the stages of the vacuum seal. Works perfectly with our roll bags and bag - 50 packs listed above.



.0015 mil Thick

Economy Freezer Bags - 100 Pack

Quail 6" x 3" x 15"	PP968	\$12.50
Capons/Fryers 8" x 4" x 18"	PP966	\$18.50
Small Turkeys 12" x 8" x 24"	PP967	\$27.95
Large Turkeys 12" x 8" x 30"	PP967	\$32.50

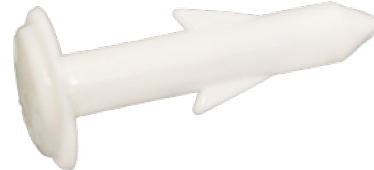

Pop Up Thermometers

PP029	Chicken Size 25 Pk	\$11.75
PP031	Chicken Size 100 Pk	\$21.00
PP027	Chicken Size 200 Pk	\$40.00
PP033	Chicken Size 1000 Pk	\$141.75
PP030	Turkey Size 25 Pk	\$11.75
PP032	Turkey Size 100 Pk	\$21.00
PP028	Turkey Size 200 Pk	\$40.00
PP034	Turkey Size 1,000 Pk	\$141.75

*While supplies last**

Roll bags make sealing a breeze!



Food Safety Label & Zip Ties		
PP976	25 pack	\$5.95
PP958	100 pack	\$9.50
PP959	1000 pack	\$74.95



We customize labels with your business info!

Add \$13.00/Per Roll

Processing Labels 250 Pk		
CN727	Plain Labels	\$22.95

Cardboard Transport

Move your birds safely and economically in one of our lightweight but durable cardboard transport options! Easy on the wallet and no clean-up later!

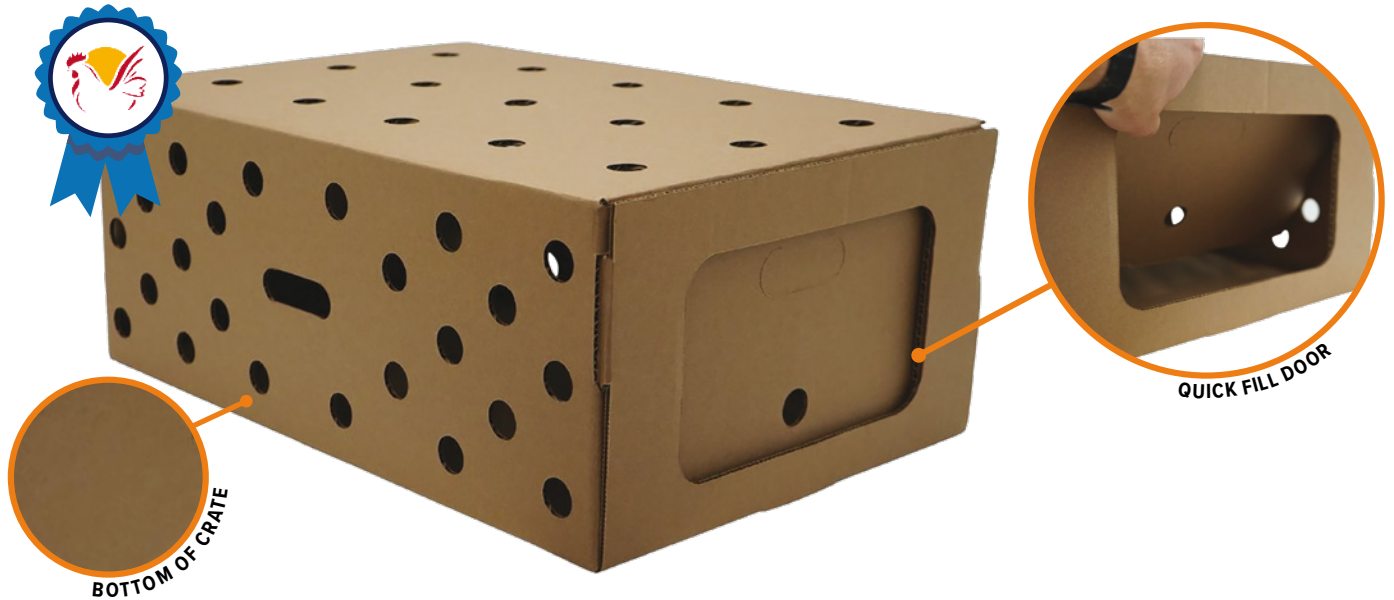

Quick Fill Cardboard Transport Crate

PP169 5 pk **\$49.95**
 PP172 Waxed Bottom Insert, 5 pk **\$18.95**

Never wash a crate again! These crates work great when you want to transport your birds but don't want to deal with washing plastic crates. This makes for a great biosecurity measure and time saver. A quick fill door means you can load birds fast and easily. A second door opens fully so you can quickly get the birds out of the box when needed. Stores flat. Made of one peice for simple assembly. For extra durability, add the waxed bottom PP172 insert to increase the floor stiffness. Biodegradable. No staples or tape needed for assembly.

Specifications:
Overall Dims: 15 1/4" W x 9.25" H x 24" L
Side Door Dims: 10" W x 5.75" H
Floor: Solid

Pairs perfectly with the Waxed Bottom Insert

GREAT FOR TRANSPORTING:

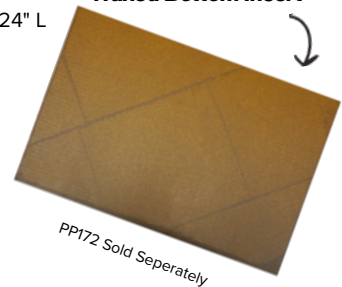

PP172 Sold Separately

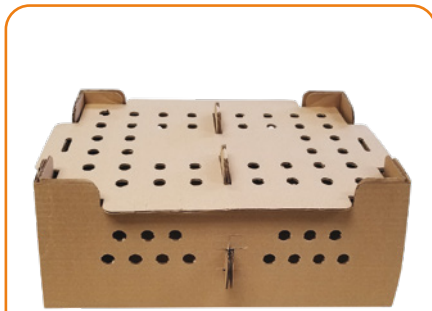

Chick Shipping Box 25 pk

PC184 50 Chick Size **\$78.95**

These baby chick boxes are made of sturdy cardboard to protect our feathered friends. The boxes include two evenly spaced compartments, have great air circulation, and are USPS approved. Sold in packs of 25. PC184 measures 19" x 12" x 6.5" and has an approximate 50 chick capacity.



Live Bird Shipping Cartons

PC181 1- 11 **\$12.95**
 12+ **\$10.75**

These shipping cartons are especially designed for shipping live adult birds. This is the "original" bird shipping crate. You can hold 1 adult chicken, 2 pigeons, 6 canaries or finches, waterfowl, etc. 1 compartment. Up to 8 lbs. total weight. 18" x 8" x 18"



Large Live Bird Shipping Cartons

PC182 1- 5 **\$36.75**
 6+ **\$31.50**

Larger size for bigger birds. Comes with dividers so you can easily separate birds. Can split it into 1, 2, or 4 compartments very easily. 16" x 16" x 16". Holds up to 90 lbs.

Transporting Your Birds

These transport crates are built with quality materials and are made to withstand years of use. The protection of your birds is important and these crates help ensure the safe transport of your birds and are easy to clean between uses.

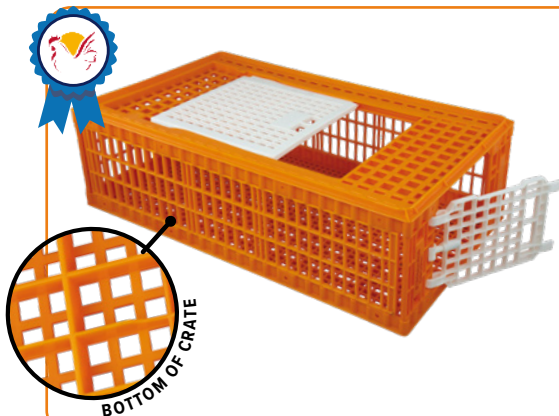

Heavy Duty Transport Crate

PC155

\$74.95

Smooth and round surfaces minimize bruises and broken wings, preventing injuries during moving. Unit has two doors the top door slides the front door is spring latched. The spring latch keeps birds safely locked in the coop. Precision interlocking reduces shifting crates when stacked. Virgin HDPE plastic that is UV stabilized for long lasting performance. This crate holds 10-18 chickens, 8-12 pheasants depending on the weight and climate. Assembly required.

Overall Dims: 22 1/2" W x 10 1/2" H x 37 5/8" L

Top Door Dims: 15 3/4" W x 12 1/2" L

Side Door Dims: 11 3/4" W x 8" H

Floor: Grid - 1/2" W x 1/2" H

GREAT FOR TRANSPORTING:

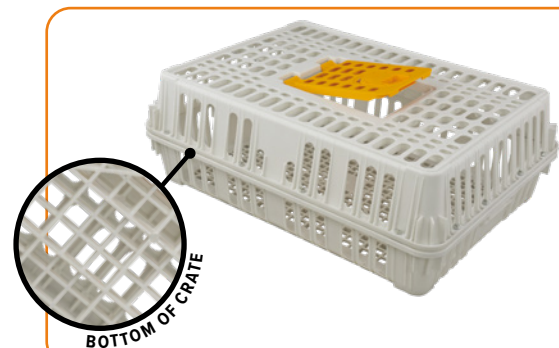

Poultry Crate

PP892

\$37.95

This transport crate is durable and has a hinged top door for quick loading of your birds. It is assembled with screws so it can be taken apart when not in use to minimize storage space. This crate holds 4-6 chickens 2-4 pheasants depending on the weight and weather conditions. Assembly required.

Overall Dims: 21" W x 10 1/2" H x 29" L

Top Door Dims: 7 3/4" W x 9 3/4" L

Floor: Grid - 1/2" W x 5/8" H

GREAT FOR TRANSPORTING:

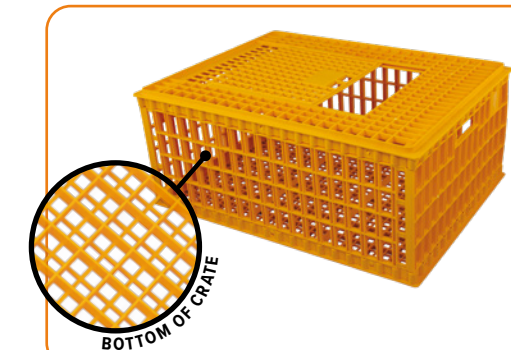

Medium Economy Transport Crate

PP891

\$42.00

Made with HDPE plastic, these crates are lightweight, durable, and maintenance free. They have a large center sliding door for easy loading and unloading of your birds. This crate holds 6-10 chickens, 4-6 pheasants depending on the weight and weather conditions. Assembly required.

Overall Dims: 21 1/2" W x 12 3/4" H x 29" L

Top Door Dims: 12" W x 9 1/8" L

Floor: Grid - 5/8" W x 5/8" H

GREAT FOR TRANSPORTING:

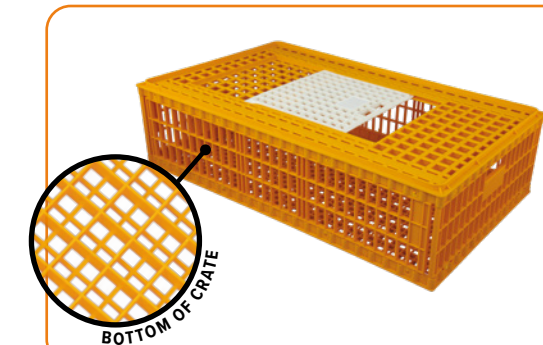

Large Economy Transport Crate

PP890

\$64.95

The large economy crate is made with HDPE plastic, they are lightweight, durable, and maintenance free. They have a large center sliding door for easy loading and unloading of your birds. This crate holds 10-18 chickens, 8-12 pheasants depending on the weight and weather conditions. Assembly required.

Overall Dims: 22 3/8" W x 10 1/2" H x 38" L

Top Door Dims: 12 3/4" W x 11" L

Floor: Grid - 1/2" W x 1/2" H

GREAT FOR TRANSPORTING:



Turkey Crate

PC156

\$79.95

Unit has two doors the top door slides the front door is spring latched. The double spring latch keeps birds safely locked in the coop. Open grated style bottom. Virgin HDPE plastic that is UV stabilized for long lasting performance. This crate holds 4-8 turkeys, depending on the weight and climate. Assembly required.

Overall Dims: 22 1/2" W x 16 3/8" H x 38" L

Top Door Dims: 15 3/4" W x 12 1/2" L

Side Door Dims: 15" W x 13 1/2" H

Floor: Grid - 1/2" W x 1/2" H

GREAT FOR TRANSPORTING:

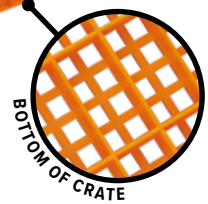

Quail Crate

PC158

\$44.95

Smooth and round surfaces minimize bruises and broken wings, preventing injuries during the coop handling. Unit has two doors the top door is spring latched the side door slides shut. Virgin HDPE plastic that is UV stabilized for long lasting performance. Capacity: 30 Quail, 5-6 Pheasant, 40 chicks or ducklings.

Overall Dims: 17 1/2" W x 6" H x 26 1/2" L

Top Door Dims: 5 3/4" W x 7 5/8" L

Side Door Dims: 4 1/2" W x 6 1/2" H

Floor: Solid

GREAT FOR TRANSPORTING:

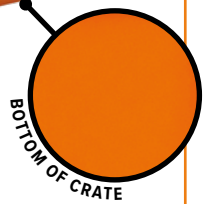

Game Bird Coop with Handle

PC180

\$34.95

Fast-fill doors snap shut to keep 5-6 game birds safe in transit. Compact and lightweight plastic crate made of durable, UV-resistant plastic. Comes in three pieces and snaps together. Features a top spring load door and fast-fill doors on both ends. Fully assembled coop weighs 5.45 lbs

Overall Dims: 14" W x 10" H x 26" L

Side Door Dims: 11" W x 7 1/4" H

Floor: Solid

GREAT FOR TRANSPORTING:

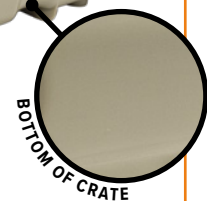
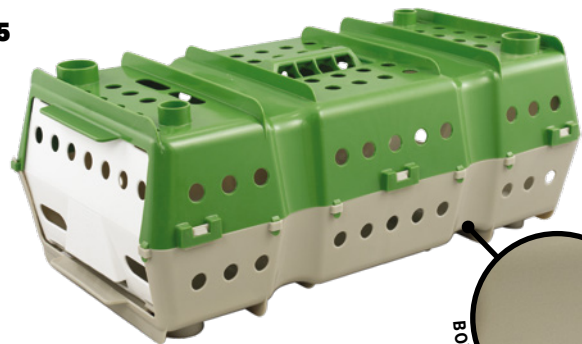

Band Size Guidelines

ACTUAL SIZE INTERNAL DIAMETER, BIRD TYPE

#4

1/4" Baby Chicks, Coturnix, Adult Bobwhite Quail, Doves

#5

5/16" Pheasant Hens, Pigeons, Tumblers, Homers, Rollers

#6

3/8" Pheasant Cocks, Month-old Chickens, Wood Ducks, Chukar Partridges

#7

7/16" Ringneck Pheasants, Mallards, Wild Ducks, Bantams, Kings, Call Ducks, Muffed Pigeons

#9

9/16" Wild Ducks, Pheasants, Leghorn Hens, Bantam Silkies, Runner Ducks, Cornish Bantams

#10

5/8" Wild Turkey, Minorcas, Adult Guineas, Runner Ducks, Polish Hens, Gamefowl, Lakenvelder, Hamburgs

#11

11/16" Rock Hens, Wyandottes, Rhode Island Hens, Leghorn Cocks, Medium Ducks, Swedish, Harlequin, Most Chicken Hens

#12

3/4" Wild Geese, Rock Hens, Turkey Hens, Jersey Giant Hens, Orpingtons, Larger Ducks: Pekins, Rouens, Muscovy, Peahens, Egyptian Geese

#13

13/16" Brahmas, Langshans, Drake Ducks, Large Duck Breeds, Cochins, Pomeranian and Buff Geese

#14

7/8" Canadian Geese, Turkeys, Medium Geese, Honkers, Jersey Giant Cocks, Peacocks, Muscovy

#16

1" Large Turkey Toms, Swans, and Large Geese: Embden, African, Toulouse



Temporary Methods of Identification

Bandettes

- Marked with large, easy-to-identify numbers
- Great for identifying individual birds

Spiral Bands

- Easy to apply
- Very popular for all bird ages

Numbered Zip Ties

- No need to measure bird legs
- Won't budge unless removed intentionally

Permanent Methods of Identification

Toe Punch

- Mark your birds once for life
- 16 distinct variation punches

Jiffy Wing Bands

- Most recommended method
- Placed in an area with no major blood vessels
- Crimped to the wing

Custom Imprinted Bands

- Easy tracking with customization
- Butt-end style



Scan the code to get tips and tricks on how to identify and tag your bird from baby chick to adulthood!

Identification bands are a must for a good breeding program and show exhibition.

Bandettes - 100 pk



*Call us for bulk quantity discounts!

Bandette Size	Red Sold as 100 Pack #s 1-100	Yellow Sold as 100 Pack #s 1-100	Blue Sold as 100 Pack #s 1-100	Green Sold as 100 Pack #s 1-100	Price per Pack
Size #5	PB624	PB625	PB626	PB627	\$27.95
Size #6	PB620	PB621	PB622	PB623	\$27.95
Size #7	PB600	PB601	PB602	PB603	\$31.95
Size #9	PB604	PB605	PB606	PB607	\$32.95
Size #11	PB608	PB609	PB610	PB611	\$37.95
Size #12	PB612	PB613	PB614	PB615	\$38.95
Size #14	PB616	PB617	PB618	PB619	\$55.95

Spiral Bands - 50 pk



Spiral Bands Size	Red Sold as 50 Pack	Yellow Sold as 50 Pack	Assorted Sold as 50 Pack	Price per Pack
Size #4	PB303	PB302	PB344	\$5.95
Size #5	PB307	PB306	PB345	\$5.95
Size #6	PB311	PB310	PB346	\$5.95
Size #7	PB315	PB314	PB347	\$5.95
Size #8	PB319	PB318	PB348	\$5.95
Size #9	PB323	PB322	PB349	\$5.95
Size #10	PB327	PB326	PB350	\$6.95
Size #11	PB331	PB330	PB351	\$6.95
Size #12	PB335	PB334	PB352	\$7.25
Size #14	PB339	PB338	PB353	\$7.25
Size #16	PB343	PB342	PB354	\$7.25



Numbered Zip Ties - 100 pk



- Works for all ages of birds
- No need to measure
- 8" long
- Numbered 1-100

Red Sold as 100 Pack	Yellow Sold as 100 Pack	Blue Sold as 100 Pack	Green Sold as 100 Pack	Pink Sold as 100 Pack	Price per Pack
PB878	PB884	PB880	PB882	PB886	\$17.95

Permanent Identification



Compound Toe Punch
PB505 **\$9.95**

Easy to use Toe Punch! With 16 punch variations, you punch a hole once and done!

There are 16 different variations to mark birds with a toe punch. Use our guide to see variations for permanent markings.

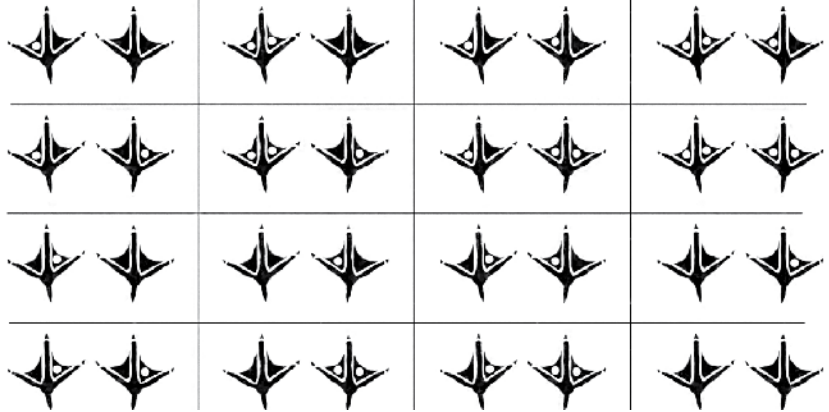

Jiffy Wing Bands 100 pk
PB369-373 **\$12.95**

One size fits all! This is the recommended method. Use the pliers to apply through the wing! Stays put indefinitely.

Red	Blue	Yellow	Green	Aluminum
PB370	PB371	PB372	PB373	PB369

Jiffy Wing Sealing Pliers
PB405 **\$15.95**

Applicator pliers for the Jiffy Wing bands.

Custom Imprinted Bands • YOUR NAME • PERMIT NUMBERS • RAFFLES



Get it customized!
Call to order
Bands ship closed

	Size #4	Size #5	Size #6	Size #7	Size #9	Size #10	Size #11	Size #12	Size #14
SKU	PB410	PB411	PB412	PB413	PB415	PB406	PB407	PB408	PB409
Qty	100	100	100	100	100	100	100	100	100
Price	\$46²⁵	\$46²⁵	\$48⁵⁰	\$48⁵⁰	\$48⁵⁰	\$57⁷⁵	\$57⁷⁵	\$57⁷⁵	\$57⁷⁵
Qty	500	500	500	500	500	500	500	500	500
Price	\$126²⁵	\$126²⁵	\$129⁹⁵	\$137⁵⁰	\$137⁵⁰	\$183⁷⁵	\$183⁷⁵	\$183⁷⁵	\$183⁷⁵
Pliers	PB210	PB211	PB212	PB213	PB220	PB215	PB216	PB217	PB218
Price	\$51⁵⁰	\$51⁵⁰	\$51⁵⁰	\$51⁵⁰	\$68²⁵	\$68²⁵	\$68²⁵	\$68²⁵	\$68²⁵

*Please note that each band requires pliers to open and close the band

Sealed Pigeon Bands 25 pk - Show and Race Approved!

2025 NPA Bands National Pigeon Association



#5 - 8mm PB225 **\$19⁹⁵** 2+ **\$16⁹⁵/PK** 4+ **\$15⁷⁵/PK**
 #6 - 9mm PB227
 #7 - 10mm PB226

2025 ARPU Bands American Racing Pigeon Union



#5 - 8mm PB355 **\$19⁹⁵** 2+ **\$16⁹⁵/PK** 4+ **\$15⁷⁵/PK**
 Band year and color will be for 2025.

Protect your Birds with Anti-Pick Solutions!

Bits

Available in different colors and 2 sizes - B or C. Easy to apply, non-intrusive, and the bits stays on until you take it off! Just load the bits into the applicator, press the lever and apply to your quail or pheasants' beaks.



Age 3-7 Weeks
Size B Bits 1000/pk **\$34⁷⁵**
 ○ White FM115
Size B Applicator FM120 **\$31⁵⁰**

Age 6-12 Weeks
Size C Bits 1000/pk **\$36⁷⁵**
 ○ White FM125 ● Orange FM126 ● Yellow FM127 ● Blue FM128
Size C Applicator FM130 **\$31⁵⁰**

Bumpa Bits

Features a piece that extends past the beak to prevent pecking and deep biting. Doesn't fall off easily like other competitors. A customer favorite!



Age 6 Weeks to Release
Bumpa Bits 100/pk **\$13⁷⁵**
 ● Brown FM135
Size D Applicator FM140 **\$31⁵⁰**
while supplies last



ScotBeak Guard

Non-intrusive beak attachment that prevents feather pecking and cannibalism in poults and adult pheasants. Allows the bird to preen, eat and drink.

Age 6 Weeks to Release
ScotBeak Guard 100/pk **\$13⁷⁵**
 ● Green FM105
Finger Loop Applicator FM110 **\$5²⁵**
while supplies last

Use for poults too!



Clip-On Spex

These high-quality peepers eliminate the need of a pin or bit! Easy to apply and quick to remove.

Age 5 Weeks to Release
Clip-On Spex 100/pk **\$17⁰⁰**
 ● Orange FM100
Apply by hand



Peepers & Hoods

Traditional style peepers and hoods offer great pecking protection while reducing the risk of getting caught in a net!

Replacement Clips & Pins Available Online!



Poly Peepers with Clips
50/pk PH268 **\$9³⁵**
while supplies last

*Flexible Specs
Rounded Sides*

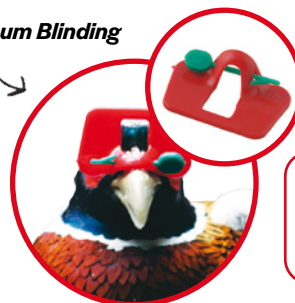

Perfect Peepers with Pins
50/pk PH270 **\$13⁰⁰**
while supplies last

Maximum Blinding

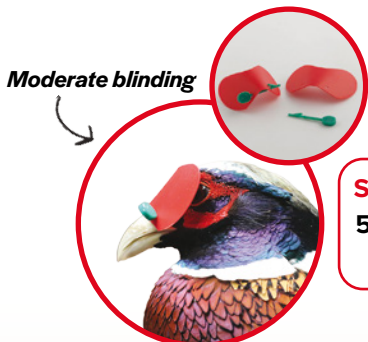

Small Hood with Pins
50/pk PH275 **\$11⁹⁵**
while supplies last

Moderate blinding



Education Essentials

Whether you're just starting on your poultry adventure or are an experienced chicken keeper looking to round-out your knowledge, we have the perfect book to cozy-up with!

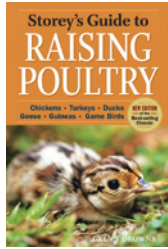

Storey's Guide to Raising Poultry
BM706 **\$20.95**

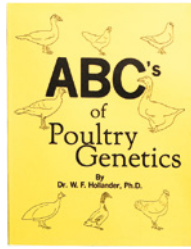

ABC's of Poultry Genetics
BM712 **\$12.50**
*While supplies last**

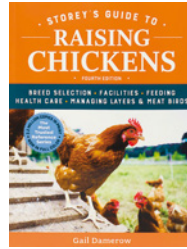

Storey's Guide to Raising Chickens
BM705 **\$26.25**



A Guide to Better Hatching
BM726 **\$9.50**



Storey's Guide to Raising Ducks
BM707 **\$23.00**

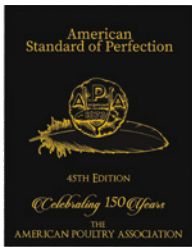

A.P.A. Standard of Perfection
BM838 **\$69.25**



Sexing All Fowl, Baby Chicks, Game Birds, Cage Birds
BM736 **\$14.75**

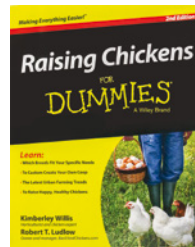

Raising Chickens for Dummies
BM710 **\$23.00**

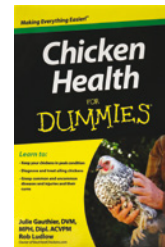

Chicken Health for Dummies
BM711 **\$19.95**
*While supplies last**



Guinea Fowl
by Van Hoesen - Stromberg

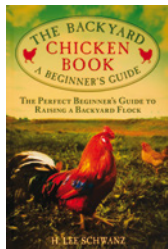

The Backyard Chicken Book
BM701 **\$19.95**



Winner! Winner! Chicken Dinner
BM899 **\$17.85**



A Kid's Guide to Keeping Chickens
BM889 **\$17.85**



The Chicken Health Handbook
BM709 **\$20.95**

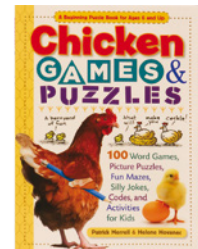

Chicken Games & Puzzles
BM887 **\$11.50**



Butchering Chickens
BM738 **\$20.95**

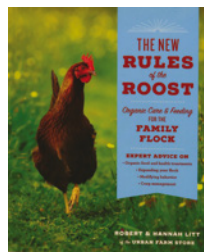

The New Rules of the Roost
BM805 **\$21.50**

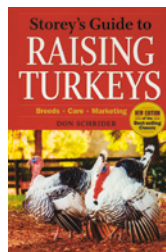

Storey's Guide to Raising Turkeys
BM708 **\$20.95**



A Guide to Pigeon Keeping
BM955 **\$15.00**

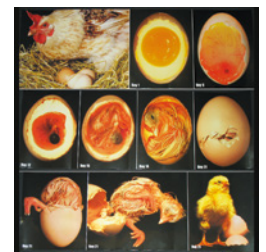

Embryology - Color Photo Poster Set
BM793 **\$28.25**

Perfect Poultry-Inspired Gifts

NEW



Stromberg's Holiday Ornaments

GF654	Acrylic Chicken Ornament	\$12.95
GF655	Mini Chicken Coop Ornament	\$17.95
GF656	Rustic Wooden Rooster Ornament	\$9.95

Add Stromberg's festive flair to your holiday decor! The Acrylic Chicken Ornament, with its clever "I'm making a list, Chicken it twice" phrase, is sure to delight friends and family. The Mini Chicken Coop Ornament brings holiday charm without the mess, while the Rustic Wooden Rooster Ornament adds a touch of rustic elegance to any space.

NEW



Chicken Plush Stuffed Animal

GF049-YW	Yellow	\$9.95
GF049-WH	White	\$9.95

This adorable chicken plush toy is treasured for their comforting and cuddly characteristics, providing a sense of safety and reassurance that children adore.



Stromberg's Stocking Hats

CL590	Black	\$12.50
CL593	Brown	\$12.95

Choose your style of comfortable and extremely fashionable hats. You'll be the envy of every flock with one on your head. Get yours today and strut your stuff!!



Stromberg's Baseball Caps

CL594	Blue	\$16.95
CL595	Dark Grey	\$16.95

Show everyone where you shop with this Stromberg's Baseball Cap.

Features Chicken Print Design

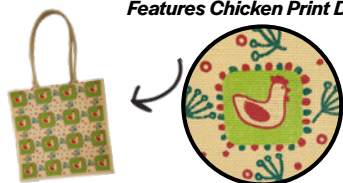

Chicken Shopping Tote Bag

GF175	Green & Red Design - Jute Material	\$4.95
-------	------------------------------------	---------------

Strut your stuff with this adorable Chicken Shopping Tote Bag. Perfect for shopping, this durable bag measures 15" x 15" x 5.5".

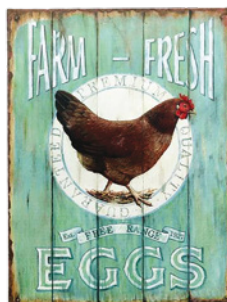

Tin Farm Fresh Free Range Eggs Sign

GF220 **\$17.50**
Show the world that you have farm fresh eggs with this rustic sign. Made of tin/metal. Features built in bracket for easy hanging. Recommended for indoor use. 10" x 13"



Farm Sweet Farm Vintage Sign

GF374 **\$33.95**
Show your love for your farm with this Farm Sweet Farm Vintage metal sign. Features a hook on the back for easy hanging. 12" x 16.5"



Wooden Mornin' Y'all Rooster Sign

GF225 **\$19.95**
Nothing says 'good morning' better than this sign! Features built in screw holes for easy hanging. Recommended for indoor use. 15.75" x 11.75"



Wooden White Rooster Sign

GF224 **\$18.95**
Bring your room to life with this sign. The white and red contrast are sure to stand out! Made of wood. Features built in screw holes for easy hanging. Recommended for indoor use. 15.75" x 11.75"



Wooden Hen & Eggs Sign

GF226 **\$19.95**
Cute farm style house sign with hen and eggs. Made of wood. Features built in screw holes for easy hanging. Recommended for indoor use. 15.75" x 11.75"



30 Qt. Poultry Fryer/Scalder Kit

PP836 Fryer/Scalder Kit
 PP838 10 qt Fry Pot/Strainer Add-on

\$61.95
\$29.95

Fry your poultry or scald your birds with ease using just one piece of equipment. This unit has a sturdy steel base with a powerful 54,000 BTU burner and a wind guard to ensure a strong flame and even cooking. The 30-quart aluminum stock pot has the capacity to fit a large turkey. The kit also includes a poultry rack, 12" probe thermometer, lift hook, and a 1 oz injector. Don't forget to purchase the additional 10 qt. Fry Pot/Strainer for perfect fried fish every time!



Chicken Themed Mugs

GF369 Rise and Shine Boho Rooster Mug **\$16.95**
 GF630 Chicken Happiness Mug **\$16.50**

Sip your favorite beverage in-style with one of these chicken themed mugs! Both mugs are made of ceramic material and are dishwasher and microwave safe.

Get cookin' with Lodge

We're your one-stop shop! Your fresh eggs and meat will taste great in the top-notch Lodge cast iron products. Don't forget our exclusive spice rub to bring the heat!



7 Quart Lodge Dutch Oven

KT024

\$76.85

A classic cooker that doesn't quit, this 7-quart Lodge Cast Iron Dutch Oven is a classic that's great for preparing and serving meals. Made of cast iron, this skillet evenly distributes heat from the bottom through the sidewalls making it the perfect tool to sear, sauté, bake, broil, braise and fry your favorite foods. It's oven safe and can be used on all cooking surfaces, grills, and campfires. Brutally tough so it will last for decades of cooking. Made in the USA.



Lodge 15" Cast Iron Skillet

KT025

\$54.85

Multi-functional cookware! Evenly distributes heat from the bottom through the sidewalls making it the perfect tool to sear, sauté, bake, broil, braise and fry your favorite foods. It's oven safe and can be used on all cooking surfaces, grills, and campfires. This will be your go-to skillet for generations to come. Made in the USA.



Rooster Rub Spices

FO115	Honey Habanero - 6 oz	\$8.00
FO116	Honey Chipotle - 6.5 oz	\$8.00
FO117	18 Spice - 5 oz	\$8.00
FO118	Buffalo Wing - 6 oz	\$8.00

While supplies last!



The Lodge Book of Dutch Oven Cooking

BM011

\$18.95



A Skillet Full

BM012

\$15.75



Bird Seasonality

Select your hatchlings and plan to purchase **as early as possible** due to high demand.

January	February	March	April	May	June	July	August	September	October	November	December
Limited Availability	Chickens - Year Round								Limited Availability		
Pre-Order	Bantams - (February -August)								Pre-Order		
Limited Availability	Ducks - Year Round								Limited Availability		
Pre-Order	Geese (March - August)								Pre-Order		
Pre-Order	Turkeys (March - August)								Pre-Order		
Pre-Order	Guineas (May - September)						Pre-Order				
Pre-Order	Peacocks (May - August)						Pre-Order				
Pre-Order	Pheasants (Mid April - August)						Pre-Order				
Pre-Order	Chukar (May - August)						Pre-Order				
Pre-Order	Quail Game (Mid April - September)								Pre-Order		
Pre-Order	Quail Coturnix (March - May)								Pre-Order		

New to ordering baby chicks and other poultry? Let our experts help!

- ✓ **AVAILABILITY:** Call us to check for specific breed availability. We coordinate with our hatchery partner to ensure hatches are scheduled weekly, but specific breeds can run out. The early bird gets the bird - order early!
- ✓ **SCHEDULING:** We will assign you the earliest available date for the combination of birds ordered when your order is placed. We will notify you of your ship date via email. If an email address is not provided, we will call the phone number on your order.
- ✓ **SEASONALITY:** Many of the breeds that you see in the catalog are seasonal, which means we cannot send them out until they are hatching. For example, Geese do not usually start hatching until March. We suggest you order early in the spring, so that you can be first on the list when your desired bird hatches!
- ✓ **SHIPPING & DELIVERY:** Your birds will ship via USPS PRIORITY MAIL on your scheduled ship date. They will arrive at your local post office (and be held for pickup) approximately 48 hours after shipping. The post office will call you upon arrival notifying you that your birds are ready for pick up. Be certain you are prepared and have your brooder warmed up, and your feeders and waterers full. We offer the largest supply of feeders and waterers to help you get started!
- ✓ **GUARANTEE:** We guarantee live delivery of your birds. You must call to report any losses within the first 48 hours of receipt. See page 146 for details.

RAISE YOUR OWN MEAT

Cornish Rock Cross Chickens are the best meat bird on the market! These cross-breed birds make very fine broilers. These birds grow very fast and produce large breast, leg, and thigh proportions, which make these birds very popular and a very cost effective investment. Shop our Cornish Rock Cross Chickens and raise your own meat in your backyard!



CORNISH ROCK CROSS CHICKS THE PERFECT MEAT BIRD

- ✓ Bred to grow fast and ready to put on weight
- ✓ Birds produce large breast, thigh, and leg meat
- ✓ Ready to process in 6-8 weeks
- ✓ Cost effective investment

Cornish Rock Cross Chicks

		25-49	50-99	100+
LC493	Not Sexed	\$3.20	\$2.65	\$2.25
LC494	Female	\$3.35	\$2.95	\$2.50
LC495	Male	\$3.35	\$2.95	\$2.50

Cornish Rock Cross Breed Traits:

- Purpose: Meat Production
- Temperament: Docile
- Broody: Non-Setter
- Weight: Male - 10 lb, Female - 6 lb

Breed Traits:

- Purpose: Meat Production
- Temperament: Docile
- Broody: Non-Setter
- Weight: Male - 10 lb, Female - 6 lb

SHOP OUR MEAT BIRD PROCESSING SUPPLIES!

Scalders & pluckers starting on page 62
Processing tools starting on page 68
Packaging supplies starting on page 74

Cornish Rock Cross prices include shipping!

Hybrid Egg Layer Chicks

Hybrid Egg Layer Chicken breeds are a great option for beginners and seasoned chicken keepers alike. These chickens have been bred specifically for their egg producing traits, hardiness, and ease to work with.



		1-4	5-9	10-14	15-24	25-49	50+
LC800	St. Run	\$4.00	\$3.85	\$3.80	\$3.75	\$3.70	\$3.60
LC802	Female	\$5.30	\$5.10	\$5.05	\$5.00	\$4.95	\$4.80
LC804	Male	\$3.45	\$3.30	\$3.30	\$3.25	\$3.20	\$3.10

Cinnamon Queen Chicks

Purpose: Egg Layer
 Egg Production: 250-320 eggs per year
 Egg Shell Color: Light Brown
 Egg Size: Large
 Temperament: Active
 Broody: Variable
 Weight: Male – 8-9 lb, Female – 6-7 lb



		1-4	5-9	10-14	15-24	25-49	50+
LC962	St. Run	\$4.00	\$3.85	\$3.80	\$3.75	\$3.70	\$3.60
LC963	Female	\$5.30	\$5.10	\$5.05	\$5.00	\$4.95	\$4.80
LC964	Male	\$3.45	\$3.30	\$3.30	\$3.25	\$3.20	\$3.10

Red Sex Link Chicks

Purpose: Egg Layer
 Egg Production: 200-280 eggs per year
 Egg Shell Color: Light Brown
 Egg Size: Large
 Temperament: Active
 Broody: Non Setter
 Weight: Male – 8-9 lb, Female – 6-7 lb



		1-4	5-9	10-14	15-24	25-49	50+
LC950	St. Run	\$4.00	\$3.85	\$3.80	\$3.75	\$3.70	\$3.60
LC951	Female	\$5.30	\$5.10	\$5.05	\$5.00	\$4.95	\$4.80
LC952	Male	\$3.45	\$3.30	\$3.30	\$3.25	\$3.20	\$3.10

Black Sex Link Chicks

Purpose: Egg Layer
 Egg Production: 200-280 eggs per year
 Egg Shell Color: Light Brown
 Egg Size: Large
 Temperament: Active
 Broody: Non Setter
 Weight: Male – 8-9 lb, Female – 6-7 lb



		1-4	5-9	10-14	15+
LC069	St. Run	\$7.90	\$7.60	\$7.50	\$7.40
LC070	Female	\$9.85	\$9.50	\$9.35	\$9.25
LC071	Male	\$6.40	\$6.15	\$6.10	\$6.00

Olive Egger Chicks

Purpose: Egg Layer
 Egg Production: 180-200 eggs per year
 Egg Shell Color: Olive green
 Egg Size: Medium-Large
 Temperament: Active
 Broody: Non Setter
 Weight: Male – 6.5 lb, Female – 5.5 lb



		1-4	5-9	10-14	15-24	25-49	50+
LC063	St. Run	\$4.55	\$4.40	\$4.35	\$4.25	\$4.20	\$4.10
LC064	Female	\$5.70	\$5.50	\$5.40	\$5.35	\$5.30	\$5.15
LC065	Male	\$3.70	\$3.05	\$3.50	\$3.45	\$3.45	\$3.35

Easter Egger Chicks

Purpose: Dual
 Egg Production: 200-280 eggs per year
 Egg Shell Color: Green, Blue, Pink
 Egg Size: Medium-Large
 Temperament: Active
 Broody: Setter
 Weight: Male – 6.5 lb, Female – 5.5 lb

Heritage Chicks

Get started with your flock or expand! Heritage chicks have four characteristics. They are recognized as an American Poultry Association Standard Breed prior to the mid-20th century, they mate naturally, they have a longer lifespan, and they have a slow growth rate. It can take 4-9 months for them to reach market weight.



White Leghorn Chicks

Purpose: Egg Layer
Egg Production: 220-300 eggs per year
Egg Shell Color: White
Egg Size: Large-Extra Large
Temperament: Very Active
Broody: Non Setter
Weight: Male – 6 lb, Female – 4.5 lb

		1-4	5-9	10-14	15-24	25-49	50+
LC710	St. Run	\$4.00	\$3.85	\$3.80	\$3.75	\$3.70	\$3.60
LC711	Female	\$5.30	\$5.10	\$5.05	\$5.00	\$4.95	\$4.80
LC712	Male	\$3.45	\$3.30	\$3.30	\$3.25	\$3.20	\$3.10



Brown Leghorn Chicks

Purpose: Egg Layer
Egg Production: 220-300 eggs per year
Egg Shell Color: White
Egg Size: Large-Extra Large
Temperament: Very Active
Broody: Non Setter
Weight: Male – 6 lb, Female – 4.5 lb

		1-4	5-9	10-14	15-24	25-49	50+
LC680	St. Run	\$4.00	\$3.85	\$3.80	\$3.75	\$3.70	\$3.60
LC681	Female	\$5.30	\$5.10	\$5.05	\$5.00	\$4.95	\$4.80
LC682	Male	\$3.45	\$3.30	\$3.30	\$3.25	\$3.20	\$3.10



Rhode Island White Chicks

Purpose: Egg Layer
Egg Production: 220-280 eggs per year
Egg Shell Color: Brown
Egg Size: Large
Temperament: Active
Broody: Variable
Weight: Male – 8.5 lb, Female – 6.5 lb

		1-4	5-9	10-14	15-24	25-49	50+
LC872	St. Run	\$4.00	\$3.85	\$3.80	\$3.75	\$3.70	\$3.60
LC873	Female	\$5.30	\$5.10	\$5.05	\$5.00	\$4.95	\$4.80
LC874	Male	\$3.45	\$3.30	\$3.30	\$3.25	\$3.20	\$3.10



Speckled Sussex Chicks

Purpose: Dual
Egg Production: 180-240 eggs per year
Egg Shell Color: Light Brown
Egg Size: Large
Temperament: Active/Curious
Broody: Setter
Weight: Male – 9 lb, Female – 7 lb

		1-4	5-9	10-14	15-24	25-49	50+
LC913	St. Run	\$4.55	\$4.40	\$4.35	\$4.25	\$4.20	\$4.10
LC914	Female	\$5.70	\$5.50	\$5.40	\$5.35	\$5.30	\$5.15
LC915	Male	\$3.70	\$3.55	\$3.50	\$3.45	\$3.45	\$3.35



Buckeye Chicks

Purpose: Dual
Egg Production: 180-260 eggs per year
Egg Shell Color: Brown
Egg Size: Large
Temperament: Active Yet Gentle
Broody: Variable
Weight: Male – 9 lb, Female – 6.5 lb

		1-4	5-9	10-14	15-24	25-49	50+
LC320	St. Run	\$7.90	\$7.60	\$7.50	\$7.40	\$7.30	\$7.15
LC321	Female	\$9.85	\$9.50	\$9.35	\$9.25	\$9.15	\$8.90
LC322	Male	\$6.40	\$6.15	\$6.10	\$6.00	\$5.95	\$5.80



Buff Brahma Chicks

Purpose: Dual
Egg Production: 150+ eggs per year
Egg Shell Color: Brown
Egg Size: Medium-Large
Temperament: Docile
Broody: Setter
Weight: Male – 12 lb, Female – 9.5 lb

		1-4	5-9	10-14	15+
LC310	St. Run	\$7.90	\$7.60	\$7.50	\$7.40
LC311	Female	\$9.55	\$9.50	\$9.35	\$9.25
LC312	Male	\$6.40	\$6.15	\$6.10	\$6.00



Dark Brahma Chicks

Purpose: Dual
Egg Production: 150+ eggs per year
Egg Shell Color: Brown
Egg Size: Medium-Large
Temperament: Docile
Broody: Setter
Weight: Male – 12 lb, Female – 9.5 lb

		1-4	5-9	10-14	15+
LC305	St. Run	\$7.90	\$7.60	\$7.50	\$7.40
LC306	Female	\$9.85	\$9.50	\$9.35	\$9.25
LC307	Male	\$6.40	\$6.15	\$6.10	\$6.00



Light Brahma Chicks

Purpose: Egg Layer
Egg Production: 180-240 eggs per year
Egg Shell Color: Brown
Egg Size: Medium-Large
Temperament: Docile
Broody: Setter
Weight: Male – 12 lb, Female – 9.5 lb

		1-4	5-9	10-14	15-24	25-49	50+
LC316	St. Run	\$4.55	\$4.40	\$4.35	\$4.25	\$4.20	\$4.10
LC317	Female	\$5.70	\$5.50	\$5.40	\$5.35	\$5.30	\$5.15
LC318	Male	\$3.70	\$3.55	\$3.50	\$3.45	\$3.45	\$3.35



		1-4	5-9	10-14	15-24	25-49	50+
LC813	St. Run	\$4.00	\$3.85	\$3.80	\$3.75	\$3.70	\$3.60
LC814	Female	\$5.30	\$5.10	\$5.05	\$5.00	\$4.95	\$4.80
LC815	Male	\$3.45	\$3.30	\$3.30	\$3.25	\$3.20	\$3.10

Rhode Island Red Chicks

Purpose: Dual
 Egg Production: 200-280 eggs per year
 Egg Shell Color: Brown
 Egg Size: Large
 Temperament: Active
 Broody: Variable
 Weight: Male – 8.5 lb, Female – 6.5 lb



		1-4	5-9	10-14	15-24	25-49	50+
LC740	St. Run	\$4.00	\$3.85	\$3.80	\$3.75	\$3.70	\$3.60
LC741	Female	\$5.30	\$5.10	\$5.05	\$5.00	\$4.95	\$4.80
LC742	Male	\$3.45	\$3.30	\$3.30	\$3.25	\$3.20	\$3.10

New Hampshire Chicks

Purpose: Dual
 Egg Production: 200-280 eggs per year
 Egg Shell Color: Brown
 Egg Size: Large-Extra Large
 Temperament: Docile
 Broody: Variable
 Weight: Male – 8.5 lb, Female – 6.5 lb

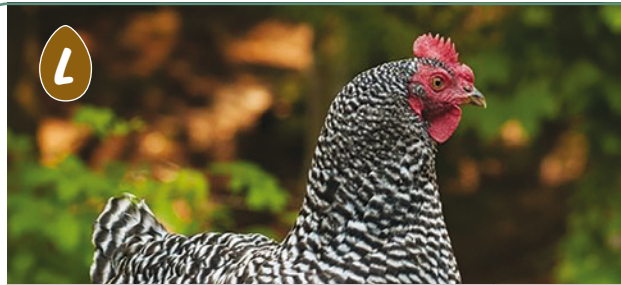

		1-4	5-9	10-14	15-24	25-49	50+
LC885	St. Run	\$4.00	\$3.85	\$3.80	\$3.75	\$3.70	\$3.60
LC886	Female	\$5.30	\$5.10	\$5.05	\$5.00	\$4.95	\$4.80
LC887	Male	\$3.45	\$3.30	\$3.30	\$3.25	\$3.20	\$3.10

Barred Plymouth Rock Chicks

Purpose: Dual
 Egg Production: 200-280 eggs per year
 Egg Shell Color: Brown
 Egg Size: Large
 Temperament: Active
 Broody: Setter
 Weight: Male – 9.5 lb, Female – 7.5 lb



		1-4	5-9	10-14	15-24	25-49	50+
LC895	St. Run	\$4.00	\$3.85	\$3.80	\$3.75	\$3.70	\$3.60
LC896	Female	\$5.30	\$5.10	\$5.05	\$5.00	\$4.95	\$4.80
LC897	Male	\$3.45	\$3.30	\$3.30	\$3.25	\$3.20	\$3.10

White Plymouth Rock Chicks

Purpose: Dual
 Egg Production: 200-280 eggs per year
 Egg Shell Color: Brown
 Egg Size: Large
 Temperament: Docile
 Broody: Setter
 Weight: Male – 9.5 lb, Female – 7.5 lb



		1-4	5-9	10-14	15-24	25-49	50+
LC801	St. Run	\$4.00	\$3.85	\$3.80	\$3.75	\$3.70	\$3.60
LC803	Female	\$5.30	\$5.10	\$5.00	\$5.00	\$4.95	\$4.80
LC805	Male	\$3.45	\$3.30	\$3.30	\$3.25	\$3.20	\$3.10

Buff Orpington Chicks

Purpose: Dual
 Egg Production: 200-280 eggs per year
 Egg Shell Color: Brown
 Egg Size: Medium
 Temperament: Docile
 Broody: Setter
 Weight: Male – 10 lb, Female – 8 lb



		1-4	5-9	10-14	15-24	25-49	50+
LC280	St. Run	\$4.00	\$3.85	\$3.85	\$3.75	\$3.70	\$3.60
LC281	Female	\$5.30	\$5.10	\$5.05	\$5.00	\$4.95	\$4.80
LC282	Male	\$3.45	\$3.30	\$3.30	\$3.25	\$3.20	\$3.10

Black Australorp Chicks

Purpose: Egg Layer
 Egg Production: 200-280 eggs per year
 Egg Shell Color: Brown
 Egg Size: Large
 Temperament: Active Yet Gentle
 Broody: Setter
 Weight: Male – 8.5 lb, Female – 6.5 lb



Columbian Rock Chicks

Purpose: Dual
 Egg Production: 200-250 eggs per year
 Egg Shell Color: Brown
 Egg Size: Large
 Temperament: Docile
 Broody: Setter
 Weight: Male – 9.5 lb, Female – 7.5 lb



		1-4	5-9	10-14	15+
LC059	St. Run	\$6.40	\$6.15	\$6.05	\$6.00



Lakenvelder Chicks

Purpose: Egg Layer
 Egg Production: 150+ eggs per year
 Egg Shell Color: Cream or Tinted
 Egg Size: Medium
 Temperament: Active/Flighty
 Broody: Non Setter
 Weight: Male – 5 lb, Female – 4 lb



		1-4	5-9	10-14	15+
LC655	St. Run	\$6.40	\$6.15	\$6.05	\$6.00



Delaware Chicks

Purpose: Egg Layer
 Egg Production: 180-260 eggs per year
 Egg Shell Color: Brown
 Egg Size: Large-Jumbo
 Temperament: Docile
 Broody: Setter
 Weight: Male – 8.5 lb, Female – 6.5 lb



		1-4	5-9	10-14	15-24	25-49	50+
LC511	St. Run	\$4.55	\$4.40	\$4.35	\$4.25	\$4.20	\$4.10
LC512	Female	\$5.70	\$5.50	\$5.40	\$5.35	\$5.30	\$5.15
LC513	Male	\$3.70	\$3.55	\$3.50	\$3.45	\$3.40	\$3.35



Dominique Chicks

Purpose: Dual
 Egg Production: 180-260 eggs per year
 Egg Shell Color: Brown
 Egg Size: Medium-Large
 Temperament: Active
 Broody: Variable
 Weight: Male – 7 lb, Female – 5 lb



		1-4	5-9	10-14	15-24	25-49	50+
LC523	St. Run	\$4.55	\$4.40	\$4.35	\$4.25	\$4.20	\$4.10
LC524	Female	\$5.70	\$5.50	\$5.40	\$5.35	\$5.30	\$5.15
LC525	Male	\$3.70	\$3.55	\$3.50	\$3.45	\$3.40	\$3.35



Black Jersey Giant Chicks

Purpose: Dual
 Egg Production: 180-260 eggs per year
 Egg Shell Color: Brown
 Egg Size: Medium
 Temperament: Docile
 Broody: Setter
 Weight: Male – 13 lb, Female – 10 lb



		1-4	5-9	10-14	15-24	25-49	50+
LC560	St. Run	\$4.55	\$4.40	\$4.35	\$4.25	\$4.20	\$4.10
LC561	Female	\$5.70	\$5.50	\$5.40	\$5.35	\$5.30	\$5.15
LC562	Male	\$3.70	\$3.55	\$3.50	\$3.45	\$3.40	\$3.35



White Jersey Giant Chicks

Purpose: Dual
 Egg Production: 180-260 eggs per year
 Egg Shell Color: Brown
 Egg Size: Medium
 Temperament: Docile
 Broody: Setter
 Weight: Male – 13 lb, Female – 10 lb



		1-4	5-9	10-14	15-24	25-49	50+
LC571	St. Run	\$7.90	\$7.60	\$7.50	\$7.40	\$7.30	\$7.15
LC572	Female	\$9.55	\$9.50	\$9.35	\$9.25	\$9.15	\$8.90
LC573	Male	\$6.40	\$6.15	\$6.10	\$6.00	\$5.95	\$5.80



Wheaten Aseel Chicks

LC044 St. Run **\$19.20**
 Purpose: Ornamental
 Egg Production: Poor
 Egg Shell Color: Cream or Tinted
 Egg Size: Small
 Temperament: Aggressive
 Broody: Setter
 Weight: Male – 5.5 lb, Female – 4 lb



Black Breasted Red Aseel Chicks

LC045 **\$19.20**
 Purpose: Ornamental
 Egg Production: Poor
 Egg Shell Color: Cream or Tinted
 Egg Size: Small
 Temperament: Aggressive
 Broody: Setter
 Weight: Male – 5.5 lb, Female – 4 lb



Salmon Faverolle Chicks

Purpose: Dual
 Egg Production: 180-240 eggs per year
 Egg Shell Color: Light Brown
 Egg Size: Medium-Large
 Temperament: Active but docile
 Broody: Variable
 Weight: Male – 8 lb, Female – 6.5 lb



		1-4	5-9	10-14	15-24	25-49	50+
LC931	St. Run	\$7.90	\$7.60	\$7.50	\$7.40	\$7.30	\$7.15
LC932	Female	\$9.55	\$9.50	\$9.35	\$9.25	\$9.15	\$8.90
LC933	Male	\$6.40	\$6.15	\$6.10	\$6.00	\$5.95	\$5.80

**Check out our website
 for full selection!**





		1-4	5-9	10-14	15-24	25-49	50+
LC971	St. Run	\$4.00	\$3.85	\$3.80	\$3.75	\$3.70	\$3.60
LC972	Female	\$5.30	\$5.10	\$5.05	\$5.00	\$4.95	\$4.80
LC973	Male	\$3.45	\$3.30	\$3.30	\$3.25	\$3.20	\$3.10

Black Laced Silver Wyandotte

Purpose: Egg Layer
 Egg Production: 180-260 eggs per year
 Egg Shell Color: Brown
 Egg Size: Medium
 Temperament: Docile
 Broody: Setter
 Weight: Male – 8.5 lb, Female – 6.5 lb



		1-4	5-9	10-14	15-24	25-49	50+
LC982	St. Run	\$4.55	\$4.40	\$4.35	\$4.25	\$4.20	\$4.10
LC981	Female	\$5.70	\$5.50	\$5.40	\$5.35	\$5.30	\$5.15
LC983	Male	\$3.70	\$3.55	\$3.50	\$3.45	\$3.45	\$3.35

Columbian Wyandotte

Purpose: Egg Layer
 Egg Production: 180-260 eggs per year
 Egg Shell Color: Brown
 Egg Size: Medium
 Temperament: Docile
 Broody: Setter
 Weight: Male – 8.5 lb, Female – 6.5 lb



		1-4	5-9	10-14	15-24	25-49	50+
LC975	St. Run	\$4.00	\$3.85	\$3.80	\$3.75	\$3.70	\$3.60
LC976	Female	\$5.30	\$5.10	\$5.05	\$5.00	\$4.95	\$4.80
LC977	Male	\$3.45	\$3.30	\$3.30	\$3.25	\$3.20	\$3.10

Black Laced Gold Wyandotte

Purpose: Egg Layer
 Egg Production: 180-260 eggs per year
 Egg Shell Color: Brown
 Egg Size: Medium
 Temperament: Docile
 Broody: Setter
 Weight: Male – 8.5 lb, Female – 6.5 lb



		1-4	5-9	10-14	15+
LC993	St. Run	\$7.90	\$7.60	\$7.50	\$7.40
LC994	Female	\$9.85	\$9.50	\$9.35	\$9.25
LC995	Male	\$6.40	\$6.15	\$6.10	\$6.00

Black Laced Red Wyandotte

Purpose: Egg Layer
 Egg Production: 180-260 eggs per year
 Egg Shell Color: Brown
 Egg Size: Medium
 Temperament: Docile
 Broody: Setter
 Weight: Male – 8.5 lb, Female - 6.5 lb



		1-4	5-9	10-14	15+
LC987	St. Run	\$7.90	\$7.60	\$7.50	\$7.40
LC988	Female	\$9.85	\$9.50	\$9.35	\$9.25
LC989	Male	\$6.40	\$6.15	\$6.10	\$6.00

Blue Laced Red Wyandotte

Purpose: Egg Layer
 Egg Production: 180-260 eggs per year
 Egg Shell Color: Brown
 Egg Size: Medium
 Temperament: Docile
 Broody: Setter
 Weight: Male – 8.5 lb, Female – 6.5 lb



		1-4	5-9	10-14	15+
LC968	St. Run	\$7.90	\$7.60	\$7.50	\$7.40
LC969	Female	\$9.85	\$9.50	\$9.35	\$9.25
LC970	Male	\$6.40	\$6.15	\$6.10	\$6.00

Splash Laced Red Wyandotte

Purpose: Egg Layer
 Egg Production: 180-260 eggs per year
 Egg Shell Color: Brown
 Egg Size: Medium
 Temperament: Docile
 Broody: Setter
 Weight: Male – 8.5 lb, Female – 6.5 lb



		1-4	5-9	10-14	15-24	25-49	50+
LC287	St. Run	\$4.00	\$3.85	\$3.80	\$3.75	\$3.70	\$3.60
LC288	Female	\$5.30	\$5.10	\$5.05	\$5.00	\$4.95	\$4.80
LC289	Male	\$3.45	\$3.30	\$3.30	\$3.25	\$3.20	\$3.10

Austra White

Purpose: Egg Layer
 Egg Production: 220-280 eggs per year
 Egg Shell Color: Very light brown to off-white
 Egg Size: Large
 Temperament: Active
 Broody: Non Setter
 Weight: Male – 6.5 lb, Female – 5 lb



		1-4	5-9	10-14	15-24	25-49	50+
LC723	St. Run	\$4.55	\$4.40	\$4.35	\$4.25	\$4.20	\$4.10
LC724	Female	\$5.70	\$5.50	\$5.40	\$5.35	\$5.30	\$5.15
LC725	Male	\$3.70	\$3.55	\$3.50	\$3.45	\$3.45	\$3.35

Cuckoo Marans

Purpose: Dual
 Egg Production: 180+ per year
 Egg Shell Color: Dark Brown
 Egg Size: Large
 Temperament: Active
 Broody: Variable
 Weight: Male – 9 lb, Female – 7 lb



		1-4	5-9	10-14	15-24	25-49	50+
LC903	St. Run	\$4.55	\$4.40	\$4.35	\$4.25	\$4.20	\$4.10
LC904	Female	\$5.70	\$5.50	\$5.40	\$5.35	\$5.30	\$5.15
LC905	Male	\$3.70	\$3.55	\$3.50	\$3.45	\$3.45	\$3.35

Welsummer

Purpose: Dual
 Egg Production: 200-280 eggs per year
 Egg Shell Color: Dark Brown
 Egg Size: Medium-Large
 Temperament: Active
 Broody: Variable
 Weight: Male – 7 lb, Female – 6 lb



		1-4	5-9	10-14	15+
LC290	St. Run	\$11.10	\$10.65	\$10.50	\$10.40
LC291	Female	\$13.85	\$13.30	\$13.15	\$13.00
LC292	Male	\$9.00	\$8.65	\$8.55	\$8.45

Barnevelder

Purpose: Dual
 Egg Production: 150-200 eggs per year
 Egg Shell Color: Dark Brown
 Egg Size: Large
 Temperament: Active
 Broody: Non Setter
 Weight: Male – 7 lb, Female – 6 lb



		1-4	5-9	10-14	15-24	25+
LC726	St. Run	\$11.10	\$10.65	\$10.45	\$10.40	\$10.25
LC727	Female	\$13.85	\$13.30	\$13.15	\$13.00	\$12.85
LC728	Male	\$9.00	\$8.65	\$8.55	\$8.45	\$8.35

French Black Copper Marans

Purpose: Egg Layer
 Egg Production: 200+ eggs per year
 Egg Shell Color: Dark Brown
 Egg Size: Large
 Temperament: Docile
 Broody: Setter
 Weight: Male – 8 lbs Female – 6.5 lb



		1-4	5-9	10-14	15-24	25+
LC733	St. Run	\$11.10	\$10.60	\$10.45	\$10.40	\$10.25
LC734	Female	\$13.85	\$13.30	\$13.15	\$13.00	\$12.85
LC735	Male	\$9.00	\$8.65	\$8.55	\$8.45	\$8.35

French Black Marans

Purpose: Egg Layer
 Egg Production: 200+ eggs per year
 Egg Shell Color: Dark Brown
 Egg Size: Large
 Temperament: Docile
 Broody: Setter
 Weight: Male – 8 lb, Female – 6.5 lb



		1-4	5-9	10-14	15-24	25+
LC350	St. Run	\$11.10	\$10.65	\$10.50	\$10.40	\$10.25
LC351	Female	\$13.85	\$13.30	\$13.15	\$13.00	\$12.85
LC352	Male	\$9.00	\$8.65	\$8.55	\$8.45	\$8.30

French Cuckoo Marans

Purpose: Dual
 Egg Production: 180+ eggs per year
 Egg Shell Color: Dark Brown
 Egg Size: Large
 Temperament: Docile
 Broody: Setter
 Weight: Male – 9 lb, Female – 6.5 lb



		1-4	5-9	10-14	15-24	25+
LC717	St. Run	\$11.10	\$10.65	\$10.50	\$10.40	\$10.25
LC718	Female	\$13.85	\$13.30	\$13.15	\$13.00	\$12.85
LC719	Male	\$9.00	\$8.65	\$8.55	\$8.45	\$8.30

French Wheaten Marans

Purpose: Dual
 Egg Production: 200+ eggs per year
 Egg Shell Color: Dark Brown
 Egg Size: Large
 Temperament: Docile
 Broody: Setter
 Weight: Male – 8 lb, Female – 6.5 lb



LC687	St. Run	\$11.10
LC688	Female	\$13.85
LC689	Male	\$9.00

Jubilee Orpington

Purpose: Dual
 Egg Production: 150+ eggs per year
 Egg Shell Color: Brown
 Egg Size: Medium
 Temperament: Docile
 Broody: Setter
 Weight: Male – 10 lb, Female – 8 lb



		1-4	5-9	10-14	15+
LC690	St. Run	\$11.10	\$10.65	\$10.50	\$10.40
LC691	Female	\$13.85	\$13.30	\$13.15	\$13.00
LC692	Male	\$9.00	\$8.65	\$8.55	\$8.45

Lavender Orpington

Purpose: Dual
 Egg Production: 150+ eggs per year
 Egg Shell Color: Brown
 Egg Size: Medium
 Temperament: Docile
 Broody: Setter
 Weight: Male – 10 lb, Female – 8 lb



		1-4	5-9	10-14	15+
LC046	St. Run	\$11.10	\$10.65	\$10.50	\$10.40
LC047	Female	\$13.85	\$13.30	\$13.15	\$13.00
LC048	Male	\$9.00	\$8.65	\$8.55	\$8.45

Bielefelder

Purpose: Dual
 Egg Production: 230 eggs per year
 Egg Shell Color: Brown
 Egg Size: Large
 Temperament: Docile
 Broody: Setter
 Weight: Male – 8.5 lb, Female – 6.5 lb



		1-4	5-9	10-14	15+
LC670	St. Run	\$11.10	\$10.65	\$10.50	\$10.40
LC671	Female	\$13.85	\$13.30	\$13.15	\$13.00
LC672	Male	\$9.00	\$8.65	\$8.55	\$8.45

Cream Legbar

Purpose: Egg Layer
 Egg Production: 180-200 eggs per year
 Egg Shell Color: Blue
 Egg Size: Medium-Large
 Temperament: Active
 Broody: Variable
 Weight: Male – 6 lb, Female – 5 lb

Blue Ameraucana
 Purpose: Egg Layer
 Egg Production: 180-200 eggs per year
 Egg Shell Color: Blue
 Egg Size: Medium-Large
 Temperament: Active/Flighty
 Broody: Non Setter
 Weight: Male – 6.5 lb, Female – 5.5 lb

Limit of 15



		1-4	5-9	10-14	15+
LC053	St. Run	\$20.00	\$19.20	\$18.95	\$18.75
LC054	Female	\$25.50	\$24.85	\$24.05	\$23.75
LC055	Male	\$16.00	\$15.35	\$15.20	\$12.00

Splash Ameraucana
 Purpose: Egg Layer
 Egg Production: 180-200 eggs per year
 Egg Shell Color: Primarily blue and some green
 Egg Size: Medium-Large
 Temperament: Active/Flighty
 Broody: Non Setter
 Weight: Male – 6.5 lb, Female – 5.5 lb

Limit of 15



		1-4	5-9	10-14	15+
LC075	St. Run	\$20.00	\$19.20	\$18.95	\$18.75
LC076	Female	\$25.30	\$24.35	\$24.05	\$23.75
LC077	Male	\$16.00	\$15.35	\$15.20	\$15.00

Lavender Ameraucana
 Purpose: Egg Layer
 Egg Production: 180-200 eggs per year
 Egg Shell Color: Primarily blue and some green
 Egg Size: Medium-Large
 Temperament: Active/Flighty
 Broody: Non Setter
 Weight: Male – 6.5 lb, Female – 5.5 lb

Limit of 15



		1-4	5-9	10-14	15+
LC072	St. Run	\$20.00	\$19.20	\$18.95	\$18.75
LC073	Female	\$25.50	\$24.85	\$24.05	\$23.75
LC074	Male	\$16.00	\$15.35	\$15.20	\$15.00

White Ameraucana
 Purpose: Egg Layer
 Egg Production: 180-200 eggs per year
 Egg Shell Color: Primarily blue and some green
 Egg Size: Medium-Large
 Temperament: Active/Flighty
 Broody: Non Setter
 Weight: Male – 6.5 lb, Female – 5.5 lb

Limit of 15



LC056	St. Run	\$20.00
LC057	Female	\$25.30
LC058	Male	\$16.00

Turken Naked Neck
 Purpose: Egg Layer
 Egg Production: 180-240 eggs per year
 Egg Shell Color: Light Brown
 Egg Size: Medium-Large
 Temperament: Docile
 Broody: Setter
 Weight: Male – 8.5 lb, Female – 6.5 lb



		1-4	5-9	10-14	15-24	25-49	50+
LC843	St. Run	\$4.55	\$4.40	\$4.35	\$4.25	\$4.20	\$4.10
LC844	Female	\$5.70	\$5.50	\$5.40	\$5.35	\$5.30	\$5.15
LC845	Male	\$3.70	\$3.55	\$3.50	\$3.45	\$3.45	\$3.35

Egyptian Fayoumis
 Purpose: Egg Layer
 Egg Production: 150-180 eggs per year
 Egg Shell Color: White
 Egg Size: Small-Medium
 Temperament: Active
 Broody: Variable
 Weight: Male – 4.5 lb, Female – 3 lb



		1-4	5-9	10-14	15+
LC550	St. Run	\$6.40	\$6.15	\$6.05	\$6.00

Hatchery's Choice Brown Egg Layers
 Assortment of brown egg layers.
 Hatchery's choice.



		1-4	5-9	10-14	15+
LC180	St. Run	\$2.95	\$2.85	\$2.75	\$2.50
LC182	Female	\$4.40	\$4.10	\$3.90	\$3.60

Check out our website for full selection!

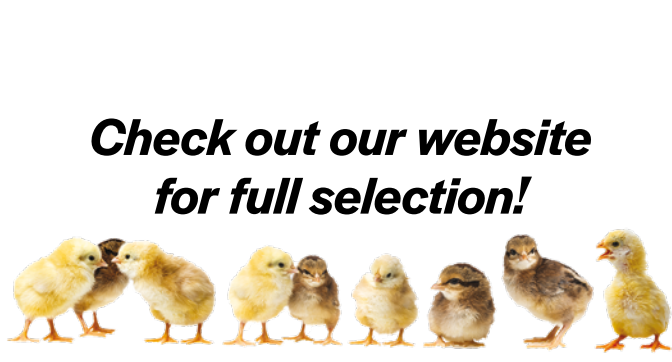

Cochin Chicks are available in Not Sexed Only



Barred Standard Cochin

LC410	1-4	5-9	10-14	15+
	\$6.40	\$6.15	\$6.05	\$6.00

Purpose: Ornamental, Exhibition
 Egg Production: 110-160 eggs per year
 Egg Shell Color: Brown
 Egg Size: Medium-Large
 Temperament: Docile
 Broody: Setter
 Weight: Male – 11 lb, Female – 8.5 lb

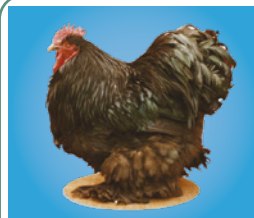

Black Standard Cochin

LC390	1-4	5-9	10-14	15+
	\$6.40	\$6.15	\$6.05	\$6.00

Purpose: Ornamental, Exhibition
 Egg Production: 110-160 eggs per year
 Egg Shell Color: Brown
 Egg Size: Medium-Large
 Temperament: Docile
 Broody: Setter
 Weight: Male – 11 lb, Female – 8.5 lb



Blue Standard Cochin

LC430	1-4	5-9	10-14	15+
	\$6.40	\$6.15	\$6.05	\$6.00

Purpose: Ornamental, Exhibition
 Egg Production: 110-160 eggs per year
 Egg Shell Color: Brown
 Egg Size: Medium-Large
 Temperament: Docile
 Broody: Setter
 Weight: Male – 11 lb, Female – 8.5 lb



Splash Standard Cochin

LC407	1-4	5-9	10-14	15+
	\$6.40	\$6.15	\$6.05	\$6.00

Purpose: Ornamental, Exhibition
 Egg Production: 110-160 eggs per year
 Egg Shell Color: Brown
 Egg Size: Medium-Large
 Temperament: Docile
 Broody: Setter
 Weight: Male – 11 lb, Female – 8.5 lb



Buff Standard Cochin

LC400	1-4	5-9	10-14	15+
	\$6.40	\$6.15	\$6.05	\$6.00

Purpose: Ornamental, Exhibition
 Egg Production: 110-160 eggs per year
 Egg Shell Color: Brown
 Egg Size: Medium-Large
 Temperament: Docile
 Broody: Setter
 Weight: Male – 11 lb, Female – 8.5 lb



Gold Laced Standard Cochin

LC440	1-4	5-9	10-14	15+
	\$6.40	\$6.15	\$6.05	\$6.00

Purpose: Ornamental, Exhibition
 Egg Production: 110-160 eggs per year
 Egg Shell Color: Brown
 Egg Size: Medium-Large
 Temperament: Docile
 Broody: Setter
 Weight: Male – 11 lb, Female – 8.5 lb



Partridge Standard Cochin

LC404	1-4	5-9	10-14	15+
	\$6.40	\$6.15	\$6.05	\$6.00

Purpose: Ornamental, Exhibition
 Egg Production: 110-160 eggs per year
 Egg Shell Color: Brown
 Egg Size: Medium-Large
 Temperament: Docile
 Broody: Setter
 Weight: Male – 11 lb, Female – 8.5 lb



Silver Laced Standard Cochin

LC470	1-4	5-9	10-14	15+
	\$6.40	\$6.15	\$6.05	\$6.00

Purpose: Ornamental, Exhibition
 Egg Production: 110-160 eggs per year
 Egg Shell Color: Brown
 Egg Size: Medium-Large
 Temperament: Docile
 Broody: Setter
 Weight: Male – 11 lb, Female – 8.5 lb



White Standard Cochin

LC450	1-4	5-9	10-14	15+
	\$6.40	\$6.15	\$6.05	\$6.00

Purpose: Ornamental, Exhibition
 Egg Production: 110-160 eggs per year
 Egg Shell Color: Brown
 Egg Size: Medium-Large
 Temperament: Docile
 Broody: Setter
 Weight: Male – 11 lb, Female – 8.5 lb

**Check out our website
 for full selection!**



Crested/Fancy Chicks are available in Not Sexed Only



Blue Polish

LC832	1-4	5-9	10-14	15+
	\$6.40	\$6.15	\$6.05	\$6.00

Purpose: Egg Layer, Exhibition
 Egg Production: Good
 Egg Shell Color: White
 Egg Size: Medium
 Temperament: Docile/Flighty
 Broody: Non Setter
 Weight: Male – 6 lb, Female – 4.5 lb



Splash Polish

LC837	1-4	5-9	10-14	15+
	\$6.40	\$6.15	\$6.05	\$6.00

Purpose: Egg Layer, Exhibition
 Egg Production: Good
 Egg Shell Color: White
 Egg Size: Medium
 Temperament: Docile/Flighty
 Broody: Non Setter
 Weight: Male – 6 lb, Female – 4.5 lb



Buff Laced Polish

LC830	1-4	5-9	10-14	15+
	\$6.40	\$6.15	\$6.05	\$6.00

Purpose: Egg Layer, Exhibition
 Egg Production: Good
 Egg Shell Color: White
 Egg Size: Medium
 Temperament: Docile/Flighty
 Broody: Non Setter
 Weight: Male – 6 lb, Female – 4.5 lb



Silver Laced Polish

LC835	1-4	5-9	10-14	15+
	\$6.40	\$6.15	\$6.05	\$6.00

Purpose: Egg Layer, Exhibition
 Egg Production: Good
 Egg Shell Color: White
 Egg Size: Medium
 Temperament: Docile/Flighty
 Broody: Non Setter
 Weight: Male – 6 lb, Female – 4.5 lb



Gold Laced Polish

LC833	1-4	5-9	10-14	15+
	\$6.40	\$6.15	\$6.05	\$6.00

Purpose: Egg Layer, Exhibition
 Egg Production: Good
 Egg Shell Color: White
 Egg Size: Medium
 Temperament: Docile/Flighty
 Broody: Non Setter
 Weight: Male – 6 lb, Female – 4.5 lb



White Crested Black Polish

LC838	1-4	5-9	10-14	15+
	\$6.40	\$6.15	\$6.05	\$6.00

Purpose: Egg Layer, Exhibition
 Egg Production: Good
 Egg Shell Color: White
 Egg Size: Medium
 Temperament: Docile/Flighty
 Broody: Non Setter
 Weight: Male – 6 lb, Female – 4.5 lb

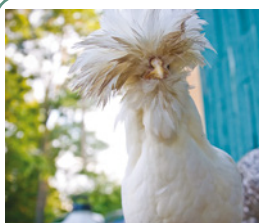

White Polish

LC842	1-4	5-9	10-14	15+
	\$6.40	\$6.15	\$6.05	\$6.00

Purpose: Egg Layer, Exhibition
 Egg Production: Good
 Egg Shell Color: White
 Egg Size: Medium
 Temperament: Docile/Flighty
 Broody: Non Setter
 Weight: Male – 6 lb, Female – 4.5 lb



Mottled Houdan

LC600	1-4	5-9	10-14	15+
	\$10.65	\$10.25	\$10.10	\$10.00

Purpose: Dual
 Egg Production: 150+ eggs per year
 Egg Shell Color: White
 Egg Size: Small-Medium
 Temperament: Docile
 Broody: Setter
 Weight: Male – 8 lb, Female – 6.5 lb

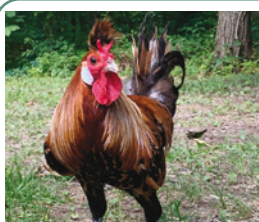

Golden Spitzhauben

LC218 **\$19.20**
 Purpose: Egg Layer, Exhibition
 Egg Production: 220-280 eggs per year
 Egg Shell Color: White
 Egg Size: Small-Medium
 Temperament: Active/Flighty
 Broody: Variable
 Weight: Male – 5 lb, Female – 4 lb

Limit of 25



Silver Spitzhauben

LC217	1-4	5-9	10-14	15+
	\$6.40	\$6.15	\$6.05	\$6.00

Purpose: Egg Laying, Exhibition
 Egg Production: 220-280 eggs per year
 Egg Shell Color: White
 Egg Size: Small-Medium
 Temperament: Active/Flighty
 Broody: Variable
 Weight: Male – 5 lb, Female – 4 lb

Crested/Fancy Chicks are available in Not Sexed Only



Crested “Top Hat” Special

LC089 **\$5.65**

Add to your backyard flock! Can include the following breeds: Polish (Silver Laced, Golden Laced, Buff Laced, White Crest Black, White Crested Blue and Splash), Silver Spangled Spitzhaubens, Golden Spitzhaubens, Mottled Houdans, and White Sultans. No guarantee of specific breed.

Silver Spangled Hamburg

LC590



1-4	5-9	10-14	15+
\$6.40	\$6.15	\$6.05	\$6.00

Purpose: Egg Layer
 Egg Production: 200+ eggs per year
 Egg Shell Color: White
 Egg Size: Medium
 Temperament: Active/Flighty
 Broody: Variable
 Weight: Male – 5 lb, Female – 4 lb

White Sultan

LC794 **\$10.65**



Purpose: Ornamental, Exhibition
 Egg Production: Fair
 Egg Shell Color: White
 Egg Size: Small
 Temperament: Active
 Broody: Variable
 Weight: Male – 6 lb, Female – 4 lb

Blue Sumatra

LC798 **\$10.65**



Purpose: Ornamental, Exhibition
 Egg Production: Fair
 Egg Shell Color: White
 Egg Size: Small
 Temperament: Active
 Broody: Setter
 Weight: Male – 5 lb, Female – 4 lb

White Chantecler

LC589 **\$10.00**



Purpose: Dual
 Egg Production: 150-200+ eggs per year
 Egg Shell Color: Brown
 Egg Size: Large
 Temperament: Docile
 Broody: Variable
 Weight: Male – 8.5 lb, Female – 6.5 lb



Rare Breeds

Not Sexed Only



White Phoenix
LC821 **\$10.65**

Purpose: Exhibition
Egg Production: Poor
Egg Shell Color: Cream or Tinted
Egg Size: Small
Temperament: Active
Broody: Setters
Weight: Male – 5.5 lb, Female – 4 lb



Black Breasted Red Phoenix
LC823 **\$6.40**

Purpose: Exhibition
Egg Production: Poor
Egg Shell Color: Cream or Tinted
Egg Size: Small
Temperament: Active
Broody: Setters
Weight: Male – 5.5 lb, Female – 4 lb



Gold Duckwing Phoenix
LC822 **\$6.40**

Purpose: Exhibition
Egg Production: Poor
Egg Shell Color: Cream or Tinted
Egg Size: Small
Temperament: Active
Broody: Setters
Weight: Male – 5.5 lb, Female – 4 lb



Silver Duckwing Phoenix

LC820 1-4 5-9 10-14 15+
\$6.40 \$6.15 \$6.05 \$6.00

Purpose: Exhibition
Egg Production: Poor
Egg Shell Color: Cream or Tinted
Egg Size: Small
Temperament: Active
Broody: Setters
Weight: Male – 5.5 lb, Female – 4 lb

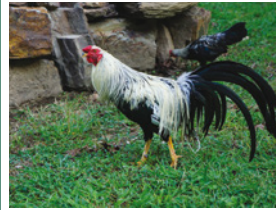

Silver Duckwing Yokohama
LC929 **\$10.65**

Purpose: Ornamental, Exhibition
Egg Production: Fair
Egg Shell Color: Cream or Tinted
Egg Size: Small
Temperament: Active
Broody: Variable
Weight: Male – 4.5 lb, Female - 3. lb



Red Shoulder Yokohama
LC939 **\$10.65**

Purpose: Exhibition
Egg Production: Fair
Egg Shell Color: Cream or Tinted
Egg Size: Small
Temperament: Active
Broody: Variable
Weight: Male – 4.5 lbs, Female – 3.5 lb



White Yokohama
LC928 **\$10.65**

Purpose: Ornamental, Exhibition
Egg Production: Fair
Egg Shell Color: Cream or Tinted
Egg Size: Small
Temperament: Active
Broody: Variable
Weight: Male – 4.5 lb, Female - 3. lb



LC203 1-4 5-9 10+
\$5.85 \$5.65 \$5.55

Long Tail Surplus

Can include any of these breeds:
Red Shouldered Yokohama,
White Yokohama, Silver
Duckwing Yokohama, Black
Breasted Red Phoenix, Silver
Duckwing Phoenix, Golden
Duckwing Phoenix, or White
Phoenix.



LC249 1-4 5-9 10+
\$5.00 \$4.80 \$4.75

Rare Breed Special

Hatchery's choice!

Not Sexed Only



Gold Duckwing Standard Old English

LC778 **\$13.85**
 Purpose: Exhibition
 Egg Production: Poor - 120 eggs per year
 Egg Shell Color: Cream or Tinted
 Egg Size: Small-Medium
 Temperament: Active/Flighty
 Broody: Setters
 Weight: Male - 5 lb, Female - 4 lb



Silver Duckwing Jungle Fowl Standard Old English

LC781 **\$13.85**
 Purpose: Exhibition
 Egg Production: Poor - 120 eggs per year
 Egg Shell Color: Cream or Tinted
 Egg Size: Small-Medium
 Temperament: Active/Flighty
 Broody: Setters
 Weight: Male - 5 lb, Female - 4 lb



White Standard Old English

LC784 **\$13.85**
 Purpose: Exhibition
 Egg Production: Poor - 120 eggs per year
 Egg Shell Color: Cream or Tinted
 Egg Size: Small-Medium
 Temperament: Active/Flighty
 Broody: Setters
 Weight: Male - 5 lb, Female - 4 lb



Black Standard Old English

LC774 **\$13.85**
 Purpose: Exhibition
 Egg Production: Poor - 120 eggs per year
 Egg Shell Color: Cream or Tinted
 Egg Size: Small-Medium
 Temperament: Active/Flighty
 Broody: Setters
 Weight: Male - 5 lb, Female - 4 lb



Black Breasted Brown Red Standard Old English

LC770 **\$13.85**
 Purpose: Exhibition
 Egg Production: Poor - 120 eggs per year
 Egg Shell Color: Cream or Tinted
 Egg Size: Small-Medium
 Temperament: Active/Flighty
 Broody: Setters
 Weight: Male - 5 lb, Female - 4 lb



Brown Breasted Brown Red Standard Old English

LC772 **\$13.85**
 Purpose: Exhibition
 Egg Production: Poor - 120 eggs per year
 Egg Shell Color: Cream or Tinted
 Egg Size: Small-Medium
 Temperament: Active/Flighty
 Broody: Setters
 Weight: Male - 5 lb, Female - 4 lb



Wheaten Standard Old English

LC785 **\$13.85**
 Purpose: Egg Laying, Exhibition
 Egg Production: Poor - 120 eggs per year
 Egg Shell Color: Cream or Tinted
 Egg Size: Small-Medium
 Temperament: Active/Flighty
 Broody: Setters
 Weight: Male - 5 lb, Female - 4 lb



Red Pyle Standard Old English

LC780 **\$13.85**
 Purpose: Egg Laying, Exhibition
 Egg Production: Poor - 120 eggs per year
 Egg Shell Color: Cream or Tinted
 Egg Size: Small-Medium
 Temperament: Active/Flighty
 Broody: Setters
 Weight: Male - 5 lb, Female - 4 lb



Ginger Red Standard Old English

LC779 **\$13.85**
 Purpose: Egg Laying, Exhibition
 Egg Production: Poor - 120 eggs per year
 Egg Shell Color: Cream or Tinted
 Egg Size: Small-Medium
 Temperament: Active/Flighty
 Broody: Setters
 Weight: Male - 5 lb, Female - 4 lb



Black Breasted Red Standard Old English

LC771 **\$13.85**
 Purpose: Exhibition
 Egg Production: Poor - 120 eggs per year
 Egg Shell Color: Cream or Tinted
 Egg Size: Small-Medium
 Temperament: Active/Flighty
 Broody: Setters
 Weight: Male - 5 lb, Female - 4 lb

Not Sexed Only



Blue Standard Old English
LC775 **\$13.85**

Purpose: Exhibition
Egg Production: Poor – 120 eggs per year
Egg Shell Color: Cream or Tinted
Egg Size: Small-Medium
Temperament: Active/Flighty
Broody: Setters
Weight: Male – 5 lb, Female – 4 lb



Splash Standard Old English
LC783 **\$13.85**

Purpose: Exhibition
Egg Production: Poor – 120 eggs per year
Egg Shell Color: Cream or Tinted
Egg Size: Small-Medium
Temperament: Active/Flighty
Broody: Setters
Weight: Male – 5 lb, Female – 4 lb



Spangled Standard Old English
LC782 **\$13.85**

Purpose: Exhibition
Egg Production: Poor – 120 eggs per year
Egg Shell Color: Cream or Tinted
Egg Size: Small-Medium
Temperament: Active/Flighty
Broody: Setters
Weight: Male – 5 lb, Female – 4 lb



Birchen Standard Old English
LC773 **\$13.85**

Purpose: Exhibition
Egg Production: Poor – 120 eggs per year
Egg Shell Color: Cream or Tinted
Egg Size: Small-Medium
Temperament: Active/Flighty
Broody: Setters
Weight: Male – 5 lb, Female – 4 lb



Silver Duckwing Standard Old English
LC786 **\$13.85**

Purpose: Exhibition
Egg Production: Poor – 120 eggs per year
Egg Shell Color: Cream or Tinted
Egg Size: Small-Medium
Temperament: Active/Flighty
Broody: Setters
Weight: Male – 5 lb, Female – 4 lb



Black Breasted Red Jungle Fowl Standard Old English
LC787 **\$13.85**

Purpose: Exhibition
Egg Production: Poor – 120 eggs per year
Egg Shell Color: Cream or Tinted
Egg Size: Small-Medium
Temperament: Active/Flighty
Broody: Setters
Weight: Male – 5 lb, Female – 4 lb



Cuckoo Standard Old English
LC776 **\$13.85**

Purpose: Exhibition
Egg Production: Poor – 120 eggs per year
Egg Shell Color: Cream or Tinted
Egg Size: Small-Medium
Temperament: Active/Flighty
Broody: Setters
Weight: Male – 5 lb, Female – 4 lb



Old English Game Fowl Assortment

LC788	1-14	15+
	\$10.80	\$10.35

Sold in 15 or 25 counts.
Guaranteed two or more varieties.

Bantam Not Sexed Only

Bantams are considered a miniature chicken and can be a third to a fifth the size compared to a standard chicken. Bantams are popular for pets, for showing, for being good broody mother hens and great for small backyards where space is limited. They come in many colors and with feather legged and clean legged types. Most of these bantam breeds are sold as not sexed but a few breeds are offered with options of pullets (female chicks). Most bantams hatch and ship between February and August, and you can start booking your order for these breeds/colors in January.

White Old English Bantam



LC757	1-9	10-14	15-24	25+
	\$7.40	\$7.20	\$7.10	\$6.90

Purpose: Ornamental, Exhibition
 Egg Production: Poor
 Egg Shell Color: Cream or Tinted
 Egg Size: Small
 Temperament: Active
 Broody: Setters
 Weight: Male – 24 oz, Female – 22 oz

Brown Red Old English Bantam

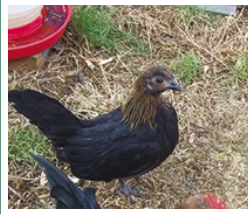

LC768	1-9	10-14	15-24	25+
	\$7.40	\$7.20	\$7.10	\$6.90

Purpose: Ornamental, Exhibition
 Egg Production: Poor
 Egg Shell Color: Cream or Tinted
 Egg Size: Small
 Temperament: Active
 Broody: Setters
 Weight: Male – 24 oz, Female – 22 oz

Crele Old English Bantam



LC758	1-9	10-14	15-24	25+
	\$7.40	\$7.20	\$7.10	\$6.90

Purpose: Ornamental, Exhibition
 Egg Production: Poor
 Egg Shell Color: Cream or Tinted
 Egg Size: Small
 Temperament: Active
 Broody: Setters
 Weight: Male – 24 oz, Female – 22 oz

Ginger Red Old English Bantam



LC761	1-9	10-14	15-24	25+
	\$7.40	\$7.20	\$7.10	\$6.90

Purpose: Ornamental, Exhibition
 Egg Production: Poor
 Egg Shell Color: Cream or Tinted
 Egg Size: Small
 Temperament: Active
 Broody: Setters
 Weight: Male – 24 oz, Female – 22 oz

Red Pyle Old English Bantam



LC762	1-9	10-14	15-24	25+
	\$7.40	\$7.20	\$7.10	\$6.90

Purpose: Ornamental, Exhibition
 Egg Production: Poor
 Egg Shell Color: Cream or Tinted
 Egg Size: Small
 Temperament: Active
 Broody: Setters
 Weight: Male – 24 oz, Female – 22 oz

Self Blue Old English Bantam



LC755	1-9	10-14	15-24	25+
	\$7.40	\$7.20	\$7.10	\$6.90

Purpose: Ornamental, Exhibition
 Egg Production: Poor
 Egg Shell Color: Cream or Tinted
 Egg Size: Small
 Temperament: Active
 Broody: Setters
 Weight: Male – 24 oz, Female – 22 oz

Silver Duckwing Old English Bantam



LC760	1-9	10-14	15-24	25+
	\$7.40	\$7.20	\$7.10	\$6.90

Purpose: Ornamental, Exhibition
 Egg Production: Poor
 Egg Shell Color: Cream or Tinted
 Egg Size: Small
 Temperament: Active
 Broody: Setters
 Weight: Male – 24 oz, Female – 22 oz

Spangled Old English Bantam



LC765	1-9	10-14	15-24	25+
	\$7.40	\$7.20	\$7.10	\$6.90

Purpose: Ornamental, Exhibition
 Egg Production: Poor
 Egg Shell Color: Cream or Tinted
 Egg Size: Small
 Temperament: Active
 Broody: Setters
 Weight: Male – 24 oz, Female – 22 oz

Wheaten Old English Bantam



LC766	1-9	10-14	15-24	25+
	\$7.40	\$7.20	\$7.10	\$6.90

Purpose: Ornamental, Exhibition
 Egg Production: Poor
 Egg Shell Color: Cream or Tinted
 Egg Size: Small
 Temperament: Active
 Broody: Setters
 Weight: Male – 24 oz, Female – 22 oz

Splash Old English Bantam



LC764	1-9	10-14	15-24	25+
	\$7.40	\$7.20	\$7.10	\$6.90

Purpose: Ornamental, Exhibition
 Egg Production: Poor
 Egg Shell Color: Cream or Tinted
 Egg Size: Small
 Temperament: Active
 Broody: Setters
 Weight: Male – 24 oz, Female – 22 oz

Bantams make great pets!



Black Breasted Red Old English Bantam

LC751	1-9	10-14	15-24	25+
	\$7.40	\$7.20	\$7.10	\$6.90

Purpose: Ornamental, Exhibition
 Egg Production: Poor
 Egg Shell Color: Cream or Tinted
 Egg Size: Small
 Temperament: Active
 Broody: Setters
 Weight: Male – 24 oz, Female – 22 oz

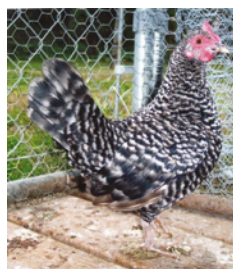

Barred Old English Bantam

LC750	1-9	10-14	15-24	25+
	\$7.40	\$7.20	\$7.10	\$6.90

Purpose: Ornamental, Exhibition
 Egg Production: Poor
 Egg Shell Color: Cream or Tinted
 Egg Size: Small
 Temperament: Active
 Broody: Setters
 Weight: Male – 24 oz, Female – 22 oz



Black Old English Bantam

LC753	1-9	10-14	15-24	25+
	\$7.40	\$7.20	\$7.10	\$6.90

Purpose: Ornamental, Exhibition
 Egg Production: Poor
 Egg Shell Color: Cream or Tinted
 Egg Size: Small
 Temperament: Active
 Broody: Setters
 Weight: Male – 24 oz, Female – 22 oz



Blue Old English Bantam

LC763	1-9	10-14	15-24	25+
	\$7.40	\$7.20	\$7.10	\$6.90

Purpose: Ornamental, Exhibition
 Egg Production: Poor
 Egg Shell Color: Cream or Tinted
 Egg Size: Small
 Temperament: Active
 Broody: Setters
 Weight: Male – 24 oz, Female – 22 oz



Brassy Back Old English Bantam

LC767	1-9	10-14	15-24	25+
	\$7.40	\$7.20	\$7.10	\$6.90

Purpose: Ornamental, Exhibition
 Egg Production: Poor
 Egg Shell Color: Cream or Tinted
 Egg Size: Small
 Temperament: Active
 Broody: Setters
 Weight: Male – 24 oz, Female – 22 oz



Dominique Bantam

LC087	1-9	10-14	15-24	25+
	\$7.40	\$7.20	\$7.10	\$6.90

Purpose: Ornamental, Exhibition
 Egg Production: Good
 Egg Shell Color: Brown
 Egg Size: Small
 Temperament: Docile
 Broody: Setters
 Weight: Male – 28 oz, Female – 24 oz

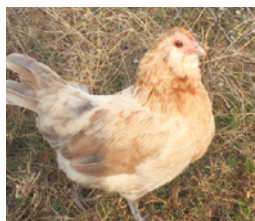

Easter Egger Bantam

LC081	1-9	10-14	15-24	25+
	\$7.40	\$7.20	\$7.10	\$6.90

Purpose: Egg Layer
 Egg Production: Fair/Good
 Egg Shell Color: Green, Blue, Pink
 Egg Size: Small
 Temperament: Active
 Broody: Setters
 Weight: Male – 35 oz, Female – 31 oz



Barred Plymouth Rock Bantam

LC880	1-9	10-14	15-24	25+
	\$7.40	\$7.20	\$7.10	\$6.90

Purpose: Egg Layer, Ornamental
 Egg Production: Good
 Egg Shell Color: Brown
 Egg Size: Small
 Temperament: Active
 Broody: Setters
 Weight: Male - 36 oz, Female - 32 oz



Black Wyandotte Bantam

LC083	1-9	10-14	15-24	25+
	\$7.40	\$7.20	\$7.10	\$6.90

Purpose: Dual Purpose
 Egg Production: 150+ eggs a year
 Egg Shell Color: Brown
 Egg Size: Small
 Temperament: Docile
 Broody: Setters
 Weight: Male – 40 oz, Female – 36 oz



Buff Orpington Bantam

LC084	1-9	10-14	15-24	25+
	\$7.40	\$7.20	\$7.10	\$6.90

Purpose: Ornamental, Exhibition
 Egg Production: Good
 Egg Shell Color: Brown
 Egg Size: Small
 Temperament: Docile
 Broody: Setters
 Weight: Male – 40 oz, Female – 36 oz

Not Sexed Only



Black Breasted Red Phoenix Bantam

LC236	1-9	10-14	15-24	25+
	\$7.40	\$7.20	\$7.10	\$6.90

Purpose: Ornamental, Exhibition
 Egg Production: Good
 Egg Shell Color: Cream or Tinted
 Egg Size: Small
 Temperament: Active
 Broody: Setters
 Weight: Male – 30 oz, Female – 28 oz

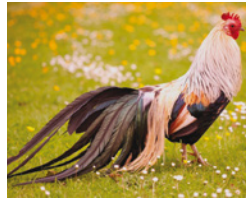

Gold Duckwing Phoenix Bantam

LC237	1-9	10-14	15-24	25+
	\$7.50	\$7.20	\$7.10	\$6.90

Purpose: Ornamental, Exhibition
 Egg Production: Good
 Egg Shell Color: Cream or Tinted
 Egg Size: Small
 Temperament: Active
 Broody: Setters
 Weight: Male – 30 oz, Female – 28 oz



Silver Duckwing Phoenix Bantam

LC238	1-9	10-14	15-24	25+
	\$7.40	\$7.20	\$7.10	\$6.90

Purpose: Ornamental, Exhibition
 Egg Production: Good
 Egg Shell Color: Cream or Tinted
 Egg Size: Small
 Temperament: Active
 Broody: Setters
 Weight: Male – 30 oz, Female – 28 oz



White Phoenix Bantam

LC239	1-9	10-14	15-24	25+
	\$7.50	\$7.20	\$7.10	\$6.90

Purpose: Ornamental, Exhibition
 Egg Production: Good
 Egg Shell Color: Cream or Tinted
 Egg Size: Small
 Temperament: Active
 Broody: Setters
 Weight: Male – 30 oz, Female – 28 oz



Wheaten Cubalaya Bantam

LC501	1-9	10-14	15-24	25+
	\$7.40	\$7.20	\$7.10	\$6.90

Purpose: Ornamental, Exhibition
 Egg Production: Fair
 Egg Shell Color: Cream or Tinted
 Egg Size: Small
 Temperament: Active
 Broody: Setters
 Weight: Male – 26 oz, Female – 22 oz



Black Breasted Red Cubalaya Bantam

LC500	1-9	10-14	15-24	25+
	\$7.40	\$7.20	\$7.10	\$6.90

Purpose: Ornamental, Exhibition
 Egg Production: Fair
 Egg Shell Color: Cream or Tinted
 Egg Size: Small
 Temperament: Active
 Broody: Setters
 Weight: Male – 26 oz, Female – 22 oz



Gold Sebright Bantam

LC942	1-9	10+
	\$7.40	\$7.20

Purpose: Ornamental, Exhibition
 Egg Production: Fair
 Egg Shell Color: Cream or Tinted
 Egg Size: Small
 Temperament: Docile/Flighty
 Broody: Non Setters
 Weight: Male – 22 oz, Female – 20 oz



Silver Sebright Bantam

LC943	1-9	10+
	\$7.40	\$7.20

Purpose: Ornamental, Exhibition
 Egg Production: Fair
 Egg Shell Color: Cream or Tinted
 Egg Size: Small
 Temperament: Docile/Flighty
 Broody: Non Setters
 Weight: Male – 22 oz, Female – 20 oz



Columbian Wyandotte Bantam

LC085	1-9	10-14	15-24	25+
	\$7.40	\$7.20	\$7.10	\$6.90

Purpose: Ornamental, Exhibition
 Egg Production: 150+ eggs per year
 Egg Shell Color: Brown
 Egg Size: Small
 Temperament: Docile
 Broody: Setters
 Weight: Male – 40 oz, Female – 36 oz



Columbian Rock Bantam

LC086	\$7.40
-------	---------------

Purpose: Ornamental, Exhibition
 Egg Production: Good
 Egg Shell Color: Brown
 Egg Size: Small
 Temperament: Docile
 Broody: Setters
 Weight: Male – 40 oz, Female – 36 oz

Not Sexed Only

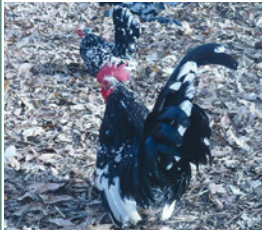

Mottled Japanese Bantam

LC627	1-9	10-14	15-24	25+
	\$7.40	\$7.20	\$7.10	\$6.90

Purpose: Ornamental, Exhibition
 Egg Production: Fair
 Egg Shell Color: Cream or Tinted
 Egg Size: Small
 Temperament: Active
 Broody: Variable
 Weight: Male – 26 oz, Female – 22 oz



White Japanese Bantam

LC628	1-9	10-14	15-24	25+
	\$7.40	\$7.20	\$7.10	\$6.90

Purpose: Ornamental, Exhibition
 Egg Production: Fair
 Egg Shell Color: Cream or Tinted
 Egg Size: Small
 Temperament: Active
 Broody: Variable
 Weight: Male – 26 oz, Female – 22 oz



Black Tailed White Japanese Bantam

LC621	1-9	10-14	15-24	25+
	\$7.40	\$7.20	\$7.10	\$6.90

Purpose: Ornamental, Exhibition
 Egg Production: Fair
 Egg Shell Color: Cream or Tinted
 Egg Size: Small
 Temperament: Active
 Broody: Variable
 Weight: Male – 26 oz, Female – 22 oz



Japanese Bantam Assortment

LC190	1-9	10-14	15-24	25+
	\$7.40	\$7.20	\$7.10	\$6.90

Hatchery's choice! This assortment can include any of the following color varieties: Black, Black Tailed Buff, Black Tailed White, Gray, Mottled, or White.



Gray Japanese Bantam

LC625	1-9	10-14	15-24	25+
	\$7.40	\$7.20	\$7.10	\$6.90

Purpose: Ornamental, Exhibition
 Egg Production: Fair
 Egg Shell Color: Cream or Tinted
 Egg Size: Small
 Temperament: Active
 Broody: Variable
 Weight: Male – 26 oz, Female – 22 oz



Black Japanese Bantam

LC620	1-9	10-14	15-24	25+
	\$7.40	\$7.20	\$7.10	\$6.90

Purpose: Ornamental, Exhibition
 Egg Production: Fair
 Egg Shell Color: Cream or Tinted
 Egg Size: Small
 Temperament: Active
 Broody: Variable
 Weight: Male – 26 oz, Female – 22 oz



Black Tailed Buff Japanese Bantam

LC623	1-9	10-14	15-24	25+
	\$7.40	\$7.20	\$7.10	\$6.90

Purpose: Ornamental, Exhibition
 Egg Production: Fair
 Egg Shell Color: Cream or Tinted
 Egg Size: Small
 Temperament: Active
 Broody: Variable
 Weight: Male – 26 oz, Female – 22 oz



Black Rosecomb Bantam

LC922	1-9	10-14	15-24	25+
	\$7.40	\$7.20	\$7.10	\$6.90

Purpose: Ornamental, Exhibition
 Egg Production: Poor
 Egg Shell Color: Cream or Tinted
 Egg Size: Small
 Temperament: Active
 Broody: Setters
 Weight: Male – 26 oz, Female – 22 oz



Blue Rosecomb Bantam

LC920	1-9	10-14	15-24	25+
	\$7.40	\$7.20	\$7.10	\$6.90

Purpose: Ornamental, Exhibition
 Egg Production: Poor
 Egg Shell Color: Cream or Tinted
 Egg Size: Small
 Temperament: Active
 Broody: Setters
 Weight: Male – 26 oz, Female – 22 oz



Splash Rosecomb Bantam

LC921	1-9	10-14	15-24	25+
	\$7.40	\$7.20	\$7.10	\$6.90

Purpose: Ornamental, Exhibition
 Egg Production: Poor
 Egg Shell Color: Cream or Tinted
 Egg Size: Small
 Temperament: Active
 Broody: Setters
 Weight: Male – 26 oz, Female – 22 oz

Not Sexed Only



Buff Brahma Bantam

LC300	1-9	10-14	15-24	25+
	\$7.40	\$7.20	\$7.10	\$6.90

Purpose: Egg Layer, Exhibition
 Egg Production: Good
 Egg Shell Color: Brown
 Egg Size: Small
 Temperament: Active
 Broody: Setters
 Weight: Male – 38 oz, Female – 34 oz



Barred Cochin Bantam

LC360	1-9	10-14	15-24	25+
	\$7.40	\$7.20	\$7.10	\$6.90

Purpose: Ornamental, Exhibition
 Egg Production: Fair
 Egg Shell Color: Brown
 Egg Size: Small
 Temperament: Docile
 Broody: Setters
 Weight: Male – 30 oz, Female – 26 oz



Blue Cochin Bantam

LC366	1-9	10-14	15-24	25+
	\$7.40	\$7.20	\$7.10	\$6.90

Purpose: Ornamental, Exhibition
 Egg Production: Fair
 Egg Shell Color: Brown
 Egg Size: Small
 Temperament: Docile
 Broody: Setters
 Weight: Male – 30 oz, Female – 26 oz



Splash Cochin Bantam

LC380	1-9	10-14	15-24	25+
	\$7.40	\$7.20	\$7.10	\$6.90

Purpose: Ornamental, Exhibition
 Egg Production: Fair
 Egg Shell Color: Brown
 Egg Size: Small
 Temperament: Docile
 Broody: Setters
 Weight: Male – 30 oz, Female – 26 oz

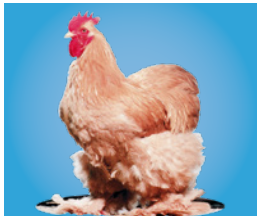

Buff Cochin Bantam

LC368	1-9	10-14	15-24	25+
	\$7.40	\$7.20	\$7.10	\$6.90

Purpose: Ornamental, Exhibition
 Egg Production: Fair
 Egg Shell Color: Brown
 Egg Size: Small
 Temperament: Docile
 Broody: Setters
 Weight: Male – 30 oz, Female – 26 oz



Black Cochin Bantam

LC364	1-9	10-14	15-24	25+
	\$7.40	\$7.20	\$7.10	\$6.90

Purpose: Ornamental, Exhibition
 Egg Production: Fair
 Egg Shell Color: Brown
 Egg Size: Small
 Temperament: Docile
 Broody: Setters
 Weight: Male – 30 oz, Female – 26 oz



Gold Laced Cochin Bantam

LC373	1-9	10-14	15-24	25+
	\$7.40	\$7.20	\$7.10	\$6.90

Purpose: Ornamental, Exhibition
 Egg Production: Fair
 Egg Shell Color: Brown
 Egg Size: Small
 Temperament: Docile
 Broody: Setters
 Weight: Male – 30 oz, Female – 26 oz



Partridge Cochin Bantam

LC376	1-9	10-14	15-24	25+
	\$7.40	\$7.20	\$7.10	\$6.90

Purpose: Ornamental, Exhibition
 Egg Production: Fair
 Egg Shell Color: Brown
 Egg Size: Small
 Temperament: Docile
 Broody: Setters
 Weight: Male – 30 oz, Female – 26 oz



Red Cochin Bantam

LC377	1-9	10-14	15-24	25+
	\$7.40	\$7.20	\$7.10	\$6.90

Purpose: Ornamental, Exhibition
 Egg Production: Fair
 Egg Shell Color: Brown
 Egg Size: Small
 Temperament: Docile
 Broody: Setters
 Weight: Male – 30 oz, Female – 26 oz



Silver Penciled Cochin Bantam

LC378	1-9	10-14	15-24	25+
	\$7.40	\$7.20	\$7.10	\$6.90

Purpose: Ornamental, Exhibition
 Egg Production: Fair
 Egg Shell Color: Brown
 Egg Size: Small
 Temperament: Docile
 Broody: Setters
 Weight: Male – 30 oz, Female – 26 oz

Not Sexed Only



White Cochon Bantam

LC382	1-9	10-14	15-24	25+
	\$7.40	\$7.20	\$7.10	\$6.90

Purpose: Ornamental, Exhibition
 Egg Production: Fair
 Egg Shell Color: Brown
 Egg Size: Small
 Temperament: Docile
 Broody: Setters
 Weight: Male – 30 oz, Female – 26 oz



Rhode Island Red Bantam

LC088	1-9	10-14	15-24	25+
	\$7.40	\$7.20	\$7.10	\$6.90

Purpose: Ornamental, Exhibition
 Egg Production: Excellent
 Egg Shell Color: Brown
 Egg Size: Small
 Temperament: Docile
 Broody: Setters
 Weight: Male – 34 oz, Female – 30 oz



Mille Fleur D`ucle Bantam

LC535	1-9	10-14	15-24	25+
	\$7.40	\$7.20	\$7.10	\$6.90

Purpose: Ornamental, Exhibition
 Egg Production: Good
 Egg Shell Color: Cream or Tinted
 Egg Size: Small
 Temperament: Docile
 Broody: Setters
 Weight: Male – 26 oz, Female – 22 oz



Porcelain D`ucle Bantam

LC536	1-9	10-14	15-24	25+
	\$7.40	\$7.20	\$7.10	\$6.90

Purpose: Ornamental, Exhibition
 Egg Production: Good
 Egg Shell Color: Cream or Tinted
 Egg Size: Small
 Temperament: Docile
 Broody: Setters
 Weight: Male – 26 oz, Female – 22 oz



Black Silkie Bantam

LC275	1-9	10-14	15-24	25+
	\$8.00	\$7.75	\$7.65	\$7.45

Purpose: Ornamental, Exhibition
 Egg Production: Good
 Egg Shell Color: Cream or Tinted
 Egg Size: Small
 Temperament: Docile
 Broody: Setters
 Weight: Male – 36 oz, Female – 32 oz



Blue Silkie Bantam

LC273	1-9	10-14	15-24	25+
	\$8.00	\$7.75	\$7.65	\$7.45

Purpose: Ornamental, Exhibition
 Egg Production: Good
 Egg Shell Color: Cream or Tinted
 Egg Size: Small
 Temperament: Docile
 Broody: Setters
 Weight: Male – 36 oz, Female – 32 oz



Splash Silkie Bantam

LC274	1-9	10-14	15-24	25+
	\$8.00	\$7.75	\$7.65	\$7.45

Purpose: Ornamental, Exhibition
 Egg Production: Good
 Egg Shell Color: Cream or Tinted
 Egg Size: Small
 Temperament: Docile
 Broody: Setters
 Weight: Male – 36 oz, Female – 32 oz



Buff Silkie Bantam

LC276	1-9	10-14	15-24	25+
	\$8.00	\$7.75	\$7.65	\$7.45

Purpose: Ornamental, Exhibition
 Egg Production: Good
 Egg Shell Color: Cream or Tinted
 Egg Size: Small
 Temperament: Docile
 Broody: Setters
 Weight: Male – 36 oz, Female – 32 oz



White Silkie Bantam

LC279	1-9	10-14	15-24	25+
	\$8.00	\$7.75	\$7.65	\$7.45

Purpose: Ornamental, Exhibition
 Egg Production: Good
 Egg Shell Color: Cream or Tinted
 Egg Size: Small
 Temperament: Docile
 Broody: Setters
 Weight: Male – 36 oz, Female – 32 oz



Silkie Surplus Bantam

LC271	1-9	10-14	15-24	25+
	\$6.85	\$6.65	\$6.55	\$6.40

In this special, it can include any of the following color varieties: White, Black, Blue, Buff, or Splash. No guarantee on breeds.

Not Sexed Only



Brown Keets

LE420	Eggs per Dozen		\$76.50
LE433	Keets	15+	\$9.15
		30+	\$6.90

Dark brown plumage with white dots. Females are darker than the males. Prolific layers of small dark eggs. Adult weight: 4 lbs.



Coral Blue Keets

LE404	Eggs per Dozen		\$68.90
LE435	Keets	15+	\$8.75
		30+	\$6.55

Medium blue with a darker coral blue on the neck, breast and back. May have a few dots and bars in the flank area, but for the most part this breed has no dots. Prolific layers of small dark eggs. Adult weight: 4 lbs.



Jumbo Keets

LE416	Eggs per Dozen		\$66.75
LE453	Keets	15+	\$8.60
		30+	\$6.40

Coloration similar to the Pearl Gray but about 30% larger. Prolific layers of small dark eggs and are produced for meat. Butcher at 16-18 weeks. Adult weight: 4 lbs.



Lavender Keets

LE405	Eggs per Dozen		\$68.90
LE436	Keets	15+	\$8.75
		30+	\$6.55

Light blue plumage with white dots. Prolific layers of small dark eggs. Adult weight: 4 lbs.



Opaline Keets

LE437	Keets	15+	\$8.75
		30+	\$6.55

White-blue color. Females are darker than the males. Prolific layers of small dark eggs. Adult weight: 4 lbs.



Pearl Gray Keets

LE407	Eggs per Dozen		\$68.65
LE439	Keets	15+	\$7.90
		30+	\$5.80

Dark gray with white dots throughout. Prolific layers of small dark eggs. Adult weight: 4 lbs.

Not Sexed Only



Pied Keets

LE451 Keets	15+	\$7.80
	30+	\$5.75

Gray, black and white plumage with white dots. May have a light rusty red color. Prolific layers of small dark eggs. Adult weight: 4 lbs.



Porcelain Keets

LE408 Eggs per Dozen		\$68.90
LE440 Keets	15+	\$8.75
	30+	\$6.55

Very pale pastel blue with white dots. Females are darker than the males. Prolific layers of small dark eggs. Adult weight: 4 lbs.



Powder Blue Keets

LE438 Keets	15+	\$8.75
	30+	\$6.55

Light blue coloring throughout, no dots or barring. Butcher at 16-18 weeks. Prolific layers of small dark eggs. Adult weight: 4 lbs.



Royal Purple Keets

LE409 Eggs per Dozen		\$68.95
LE441 Keets	15+	\$8.75
	30+	\$6.50

Dark black plumage with a purple sheen. May have some barring or dots in the flank area. Often confused with the Pearl Gray until their first molt. Prolific layers of small dark eggs. Adult weight: 4 lbs.



Sky Blue Keets

LE452 Keets	15+	\$9.15
	30+	\$6.90

Medium blue with a darker coral blue on the breast, neck and back with a touch of blue lacing. Prolific layers of small dark eggs. Adult weight: 4 lbs.



White African Keets

LE411 Eggs per Dozen		\$65.65
LE443 Keets	15+	\$7.90
	30+	\$5.85

Pure white plumage with sparse black hairs on the back of the neck. Lighter colored skin, as well as the meat. Butcher at 16-18 weeks. Prolific layers of small dark eggs. Adult weight: 4 lbs.

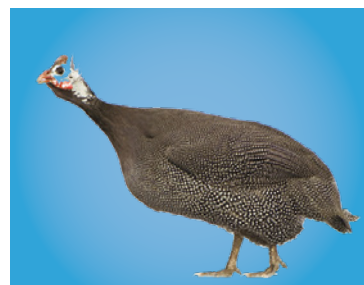

Assorted Fancy Keets

LE430 Keets	15+	\$9.15
	30+	\$6.90

Beautiful assortment of the Fancy breeds! Minimum of 4+ colors. Choices may include: Buff, Coral Blue, Lavender, Opaline, Porcelain, and Royal Purple.

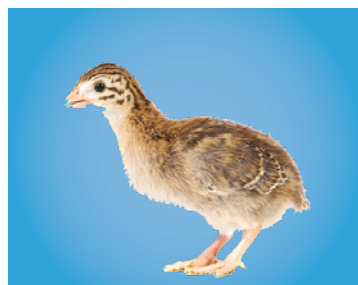

Assorted Keets

LE401 Eggs per Dozen		\$65.65
LE431 Keets	15+	\$8.30
	30+	\$6.20

This assortment will include Pearl Gray and/or White African and 1-2 other fancy colors.



Prices include shipping!

Meat Turkeys

We offer several beautiful varieties of turkey poults and eggs ranging from Black Spanish to Bourbon Red and more. Turkey poults typically ship from March - August and fertile turkey eggs from May - July.



Broad Breasted White

LP362 Not Sexed	1 - 4	\$12.80
	5-14	\$12.60
	15-19	\$12.45
	20-39	\$12.00
	40+	\$12.00
LP308 Hatching Eggs	15	\$135.00
LP318	40	\$250.00

Most common of commercial broad breasted strains of eating Turkeys on the market! Primarily bred for meat production and are docile. Origin: North America. Female weight: 22 lb. Male weight: 34 lb.



Broad Breasted Bronze

LP361 Not Sexed	1 - 4	\$18.10
	5-14	\$17.90
	15-19	\$17.65
	20-39	\$17.00
	40+	\$17.00
LP307 Hatching Eggs	15	\$135.00
LP317	40	\$250.00

One of the largest and heaviest of the turkey variety! Excellent for meat production. Origin: North America. Female weight: 21 lb. Male weight: 29 lb.



Royal Palm

LP359 St. Run **\$18.10**

Rare breed that is considered to be smaller than other heritage turkeys. Beautiful color pattern makes them great for exhibition. Poor at producing eggs but do go broody. Origin: North America. Female weight: 10 lb. Male weight: 16 lb.



Bourbon Red

LP360 St. Run **\$18.10**

Rare breed with a beautiful color pattern! Can be used for exhibition, egg laying, and meat. Origin: North America. Female weight: 14 lb. Male weight: 23 lb.



Narragansett

LP365 St. Run **\$19.20**

Rare breed that makes an excellent backyard turkey and are very good with insect population. Good for exhibition. Origin: North America. Female weight: 14 lb. Male weight: 23 lb.



Black Spanish

LP358 St. Run **\$18.10**

Rare breed of the heritage turkey! Iridescent solid black color as they grow. This breed is active and do go broody. Origin: North America. Female weight: 14 lb. Male weight: 23 lb.



Standard Bronze Heritage

LP366 St. Run **\$19.20**

A favorite breed for the homesteader or family farmer! Breeds naturally and are very good at foraging. Origin: North America. Female weight: 14 lb. Male weight: 23 lb.



Blue Slate

LP364 St. Run **\$18.10**

Rare breed of the heritage turkey! Makes an excellent forager and backyard turkey. Capable of reproducing naturally and go broody. Origin: North America. Female weight: 14 lb. Male weight: 23 lb.

Surplus Rare

LP368 St. Run **\$18.00**

Get a hatchery's choice and let us surprise you! Can include any of the following: Bourbon Red, Royal Palm, Blue Slate, Narragansett, Bronze Heritage Standard Turkey, and Black Spanish. Breed variety is not guaranteed. It is possible to get all of one kind.



Surplus Turkey Special

LP372 St. Run 1 - 14 **\$18.00**
15+ **\$18.00**

Get a hatchery's choice and save money! Will include color variety and at least two of the eight turkey breeds.

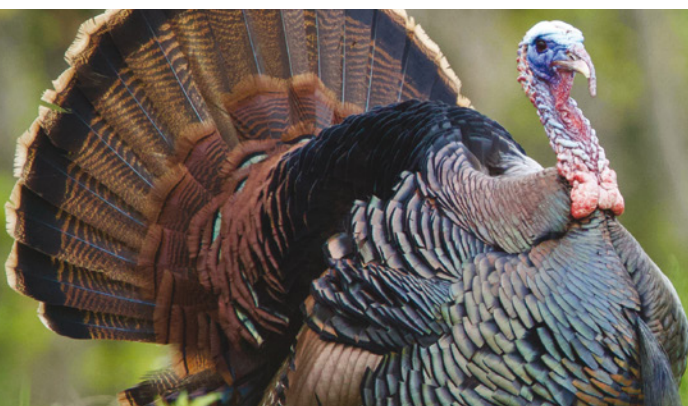

Ducklings



Jumbo Pekin

Bred for size and meat production. High fertility and good egg production.

		1-29	30-124	125+
LE681	Not Sexed	\$12.50	\$9.95	\$8.35
LE682	Female	\$16.80	\$13.75	\$11.45
LE683	Male	\$14.00	\$11.30	\$9.40



Rouen

Beautiful coloration! Have a deep keel. Very calm and non-show birds. Good foragers and good producers of fine quantities of fertile eggs. Said to have flavorful meat.

		1-29	30-124	125+
LE687	Not Sexed	\$10.90	\$8.50	\$7.15
LE688	Female	\$15.40	\$12.50	\$10.40
LE689	Male	\$8.35	\$6.25	\$5.30



Khaki Campbell

Popular breed due to its excellent egg production! Khaki color.

		1-29	30-124	125+
LE663	Not Sexed	\$10.95	\$8.60	\$7.20
LE664	Female	\$15.50	\$12.60	\$10.45
LE665	Male	\$8.40	\$6.30	\$5.35

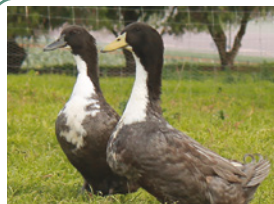

Blue Swedish

Features a white patch on the chest. Blue birds do not breed true. If you mate a Blue Swedish with another Blue Swedish, only 50% will hatch blue. Must have heterozygote parents to produce the blue color. Features a white patch on the chest. Very hardy.

		1-29	30-124	125+
LE714	Not Sexed	\$11.15	\$8.80	\$7.40
LE715	Female	\$15.80	\$12.85	\$10.70
LE716	Male	\$8.55	\$6.45	\$5.45

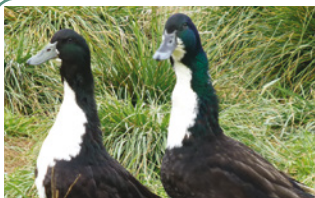

Black Swedish

Hardy, strong breed with good foraging ability. Breeds true.

		1-29	30-124	125+
LE711	Not Sexed	\$11.15	\$8.80	\$7.40
LE712	Female	\$15.80	\$12.85	\$10.70
LE713	Male	\$8.55	\$6.45	\$5.45



Buff

Beautiful and popular breed! Good multipurpose bird. Good for producing eggs and its size and feather color make it a good roasting duck. Breeds true.

		1-29	30-124	125+
LE708	Not Sexed	\$11.15	\$8.80	\$7.40
LE709	Female	\$15.80	\$12.85	\$10.70
LE710	Male	\$8.55	\$6.45	\$5.45



Cayuga

Very hardy duck with eggs that have different shades of gray in the shell color. Has green sheen to their feathers. As they age, this breed can become almost all white and their black legs turn more orangish in color.

		1-29	30-124	125+
LE669	Not Sexed	\$11.15	\$8.80	\$7.40
LE670	Female	\$15.80	\$12.85	\$10.70
LE671	Male	\$8.55	\$6.45	\$5.45

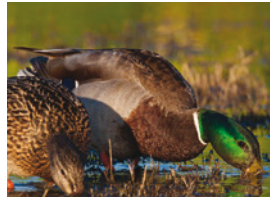

Mallard

Sometimes called "Greenhead". Can be used for pets, dog training, and hunting preserves! Excellent flying ability and job of hatching and raising ducklings. Start flying at around 10-12 weeks.

		1-29	30-124	125+
LE675	Not Sexed	\$11.15	\$8.80	\$7.40
LE676	Female	\$15.80	\$12.85	\$10.70
LE677	Male	\$8.55	\$6.45	\$5.45



Golden 300 Hybrid

Lays more and larger eggs, have a higher fertility, and are calm. Males are shades of black and females are shades of brown. If mating, please note that there is no relationship between sex and color.

		1-29	30-124	125+
LE678	Not Sexed	\$11.40	\$8.95	\$7.50
LE679	Female	\$16.15	\$13.15	\$10.95
LE680	Male	\$8.70	\$6.55	\$5.55



White Layer

Good white egg laying bird! Mostly calm breed.

		1-29	30-124	125+
LE666	Not Sexed	\$11.40	\$8.95	\$7.50
LE667	Female	\$16.15	\$13.15	\$10.95
LE668	Male	\$8.70	\$6.55	\$5.55



Fawn & White Runner

Known for good egg production and excellent mobility. Light weight and are great at foraging. Origin: Southeast Asia.

		1-29	30-124	125+
LE696	Not Sexed	\$11.90	\$9.45	\$7.90
LE697	Female	\$16.95	\$13.90	\$11.55
LE698	Male	\$9.10	\$6.90	\$5.85



Black Runner

Known for good egg production and excellent mobility. Light weight and are great at foraging. Origin: Southeast Asia.

		1-29	30-124	125+
LE699	Not Sexed	\$11.90	\$9.45	\$7.90
LE700	Female	\$16.95	\$13.90	\$11.55
LE701	Male	\$9.10	\$6.90	\$5.85



Blue Runner

Known for good egg production and excellent mobility. Light weight and are great at foraging. Origin: Southeast Asia.

		1-29	30-124	125+
LE702	Not Sexed	\$11.90	\$9.45	\$7.90
LE703	Female	\$16.95	\$13.90	\$11.55
LE704	Male	\$9.10	\$6.90	\$5.85



Chocolate Runner

Known for good egg production and excellent mobility. Light weight and are great at foraging. Origin: Southeast Asia.

		1-29	30-124	125+
LE693	Not Sexed	\$11.90	\$9.45	\$7.90
LE694	Female	\$16.95	\$13.90	\$11.55
LE695	Male	\$9.10	\$6.90	\$5.85



White Crested

Classic breed used for eggs and meat. Crest located on the head.

		1-29	30-124	125+
LE672	Not Sexed	\$13.75	\$11.00	\$9.20
LE673	Female	\$19.70	\$16.25	\$13.45
LE674	Male	\$10.40	\$8.05	\$6.80



Welsh Harlequin

Popular breed due to their multipurpose characteristics! They are calm, curious, and excellent foragers. Males have dark bills. Females have lighter bills that end with a dark spot. Origin: Wales.

		1-29	30-124	125+
LE658	Not Sexed	\$13.10	\$10.50	\$8.75
LE659	Female	\$18.80	\$15.55	\$12.85
LE660	Male	\$9.90	\$7.65	\$6.45



Silver Appleyard

One of the most active foragers and best egg layers among the heavy weight ducks! Can often hatch and raise their own. Said to have flavorful meat.

		1-29	30-124	125+
LE690	Not Sexed	\$14.95	\$12.15	\$10.10
LE691	Female	\$21.55	\$18.00	\$14.85
LE692	Male	\$11.20	\$8.80	\$7.40



Saxony

Excellent dual-purpose bird! Has light-colored undercoat of feathers. Very large and gentle. Active forager.

		1-29	30-124	125+
LE705	Not Sexed	\$18.05	\$14.65	\$12.20
LE706	Female	\$27.25	\$22.75	\$18.75
LE707	Male	\$13.50	\$10.65	\$8.90



Duclair

Does well as pasture or free range grown. Said to have a rich flavor. Origin: France.

		1-29	30-124	125+
LE717	Not Sexed	\$11.70	\$9.25	\$7.75
LE718	Female	\$15.65	\$12.75	\$10.60
LE719	Male	\$13.10	\$10.50	\$8.75



Grimaud Hybrid Pekin

Fast growing, feed efficient duck! Primarily used for meat production. It is of 100% Pekin blood. Age at slaughter: 49 days.

		2-29	30-124	125+
LE684	Not Sexed	\$10.45	\$8.15	\$6.85
LE685	Female	\$13.90	\$11.15	\$9.30
LE686	Male	\$11.65	\$9.20	\$7.70



Mixed Ducklings

Breeder's choice! Any breed can be included, ranging from the common Pekin to the rare Silver Appleyard.

		1-29	30-124	125+
LE721	Not Sexed	\$8.75	\$6.70	\$5.65
LE722	Female	\$12.25	\$9.75	\$8.15
LE723	Male	\$6.85	\$5.00	\$4.25



Assorted Runner

Save money and be surprised! Cannot order specific colors.

		2-29	30-124	125+
LE724	Not Sexed	\$11.10	\$8.70	\$7.30
LE725	Female	\$15.70	\$12.80	\$10.60
LE726	Male	\$8.50	\$6.40	\$5.45

Goslings

Geese are entertaining and great to eat! Waterfowl are shipped when they are freshly hatched out of our hatchers on Mondays and Wednesdays. A goose is good for producing down for insulation, meat for food, warding off threats, and keeping your pond active. If you nurture them, they can make great pets.



Super African

Best guard goose! Very vocal. Large with a well-developed dewlap. Origin: China.

		2-15	16-63	64+
LG206	Not Sexed	\$68.45	\$68.45	\$68.45
LG207	Female	\$115.45	\$115.45	\$115.45
LG208	Male	\$52.75	\$52.75	\$52.75



Buff Toulouse

Very distinctive coloration and disposition of Buffs.

		2-15	16-63	64+
LG239	Not Sexed	\$55.95	\$52.20	\$47.05
LG240	Female	\$93.60	\$89.35	\$80.60
LG241	Male	\$43.40	\$39.85	\$35.90



Large Dewlap Toulouse

Great exhibition bird! Its unique characteristics are the large dewlap of skin below their beak, a deep keel handing from the breast, and two lobes in their full paunch. Calm. Fertility may be a problem.

		2-15	16-63	64+
LG245	Not Sexed	\$160.00	\$160.00	\$160.00
LG246	Female	\$275.65	\$275.65	\$275.65
LG247	Male	\$121.45	\$121.45	\$121.45



Sebastopol

Very unique looking! Pure white. Feathers do not insulate them well so in cold weather they may spend more time inside than other breeds. Poor fertility and egg production.

		2-15	16-63	64+
LG233	Not Sexed	\$150.35	\$150.35	\$150.35
LG234	Female	\$285.55	\$258.55	\$258.55
LG235	Male	\$114.25	\$114.25	\$114.25



French Toulouse

Utility goose that is very hardy and grown commercially in France. Fast growers. Not an exhibition Toulouse.

		2-15	16-63	64+
LG242	Not Sexed	\$34.60	\$31.15	\$28.05
LG243	Female	\$56.20	\$52.50	\$47.30
LG244	Male	\$27.40	\$24.05	\$21.60



Tufted Toulouse

Calm breed that is fast growing! Utility goose that is very hardy and grown commercially in France.

		2-15	16-63	64+
LG248	Not Sexed	\$44.05	\$40.35	\$36.35
LG249	Female	\$72.60	\$68.50	\$61.75
LG250	Male	\$34.55	\$30.95	\$27.90



Mixed Goslings

Breeder's choice! Can include anything from the common Embden to the rare Sebastopol.

		2-15	16-63	64+
LG200	Not Sexed	\$22.10	\$19.30	\$17.40
LG201	Female	\$35.05	\$32.05	\$28.85
LG202	Male	\$17.80	\$15.05	\$13.50

Goslings



White Chinese

One of the smallest domesticated geese breeds! Has a long neck and snow-white feathers. Very talkative, making them the perfect choice if you want to be alerted to intruders. Mostly used for weeding purposes. Great for orchards, gardens, and pastures. Prolific egg-layer, laying around 30-45 eggs per year. Origin: China.

		2-15	16-63	64+
LG218	Not Sexed	\$23.85	\$21.05	\$18.90
LG219	Female	\$38.10	\$35.10	\$31.60
LG220	Male	\$19.10	\$16.35	\$14.70

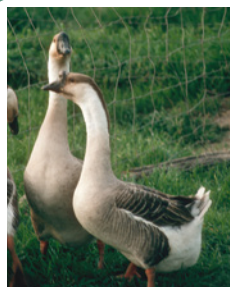

African

Beautiful midsized breed that are very active foragers! Good egg producers with above average fertility. If you live in northern climates, it's recommended to provide them shelter as their knobs can become frostbitten if they are not given sufficient protection from the cold. Origin: China.

		2-15	16-63	64+
LG203	Not Sexed	\$24.30	\$21.45	\$19.30
LG204	Female	\$38.85	\$35.85	\$32.25
LG205	Male	\$19.45	\$16.65	\$15.00



Brown Chinese

Small, light, and elegant breed! Has a pronounced knob on their head. Origin: China.

		2-15	16-63	64+
LG215	Not Sexed	\$36.20	\$32.70	\$29.45
LG216	Female	\$58.95	\$55.15	\$49.70
LG217	Male	\$28.60	\$27.50	\$26.20

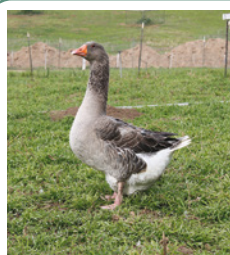

Toulouse

One of the best breeds for hatching and raising their own young! Dark feathers for a neater and cleaner look. Sturdy, durable breed that lay a good number of fertile eggs. Origin: France.

		2-15	16-63	64+
LG236	Not Sexed	\$32.45	\$28.90	\$26.00
LG237	Female	\$52.25	\$48.45	\$43.65
LG238	Male	\$25.85	\$22.40	\$20.10



Embden

Most common goose used for commercial meat production! Snowy-white color with a stout, round body, neck, and round head. Quick grower and large in size. Easy to breed. Hardy and lay good quantities of eggs. Origin: Germany.

		2-15	16-63	64+
LG221	Not Sexed	\$25.35	\$22.45	\$20.20
LG222	Female	\$34.55	\$31.50	\$28.40
LG223	Male	\$28.45	\$25.45	\$22.90



Buff

Calm and friendly breed that features unique buff-colored feathering. Developed for commercial meat production.

		2-15	16-63	64+
LG209	Not Sexed	\$43.35	\$39.70	\$35.75
LG210	Female	\$71.40	\$67.30	\$60.70
LG211	Male	\$34.05	\$30.50	\$27.45



Pilgrim

Calm and known to be excellent parents! Males are white with some gray on the rump or wings. Females are gray and often have white on the head. Eggs have a low fertility rate.

		2-15	16-63	64+
LG224	Not Sexed	\$46.10	\$42.35	\$38.15
LG225	Female	\$76.15	\$72.00	\$64.90
LG226	Male	\$36.05	\$32.45	\$29.25

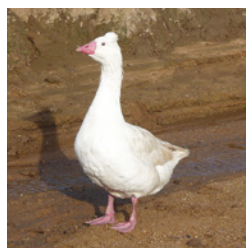

Tufted Roman

One of the oldest breeds! Smaller breed that is friendly, active, and docile. Its crest occurs due to a group of feathers that stand more upright, creating the appearance of a small helmet on their head. Origin: Italy.

		2-15	16-63	64+
LG227	Not Sexed	\$42.05	\$38.35	\$34.55
LG228	Female	\$69.00	\$64.95	\$58.60
LG229	Male	\$33.05	\$29.45	\$26.50

Pheasant & Chukars

You may need a permit for pheasants. Check with your state's wildlife department. Some states require a special health certificate.



Chinese Ringneck Pheasant

LP130	Not Sexed	30 - 99	\$3.35
		100 - 199	\$3.05
		200+	\$2.95

One of the most popular birds used by hunting preserves and sportsman's clubs! Known to be a powerful flyer. Blue-green head with a distinctive red ring around the eyes and white ring on the neck. 20 weeks to maturity. Live Weight: Male 2 lbs at 26 weeks.

Prices include shipping!



Chukar Partridge

LP202	Not Sexed	Box of 50	\$162.50
		2+ Boxes	\$154.50

Stout gray bird with light, silky smooth feathers on its head and a distinctive black band passing across its eyes, circling the face and ending at a V at the throat. It has orange legs and a beak that grows so fast that it must be de-beaked often. 26-28 weeks to maturity and then begins laying, following mating season. Origin: India. Chukar partridge chicks will begin shipping in mid May. Sold in boxes of 50.

Prices include shipping!

Pheasant

You may need a permit for pheasants. Check with your state's wildlife department. Some states require a special health certificate.



XL Ringneck Pheasant

	30-49	50+
LP168 Not Sexed	\$5.25	\$4.85

A great meat bird! Not as large as the Jumbo Ringneck Pheasant, but about 30% larger than the regular Ringneck. Same plumage color as the Ringneck. The breed is primarily of Mongolian blood and is a challenging bird for dogs to get into flight as it tends to be a ground runner. Female weight: 2.5-3 lb. Male weight: 3.5-4 lb.



Manchurian Cross Pheasant

	30-49	50+
LP170 Not Sexed	\$5.00	\$4.65

Looking to propagate your land? This breed is the perfect fit! These birds have great naturally wild characteristics, which are seen in their physical appearance and performance. Female weight: 2.5 lb. Male weight: 3.25 lb.



Melanistic Mutant Pheasant

	30-49	50+
LP167 Not Sexed	\$5.00	\$4.65

Color variation out of the Ringneck; Iridescent green-black sheen. Similar in size to the Ringneck. Female weight: 2.5 lb. Male weight: 3.25 lb.



Kansas Pheasant

	30-49	50+
LP169 Not Sexed	\$4.65	\$4.30

Explosive, high-flying bird that will surely create a buzz with the guests at your hunt club or your hunt club buyers! This bird is blue backed and is efficient with a good feed conversion rate. It is a smaller pheasant. Female weight: 1.6 - 1.8 lb. Male weight: 2.25-2.5 lb.

Prices include shipping!

FREE SHIPPING ON MOST ORDERS \$150+

Quail Not Sexed Only

Baby quail are delicate to ship due to their small size. They require a high level of protein (28%). You can feed them a turkey starter if special game bird feed is not available. We advise grinding feed in a blender to powder consistency.



Northern Bobwhite
Great fliers and layers! Mature in 16 weeks and dresses out at 7-9 oz. Productive at 24 weeks.

LQ201 Chicks	100-199	\$2.50
	200+	\$2.30
LQ101 Eggs	30 - 49	\$1.70
	50 - 99	\$1.55
	100+	\$1.45

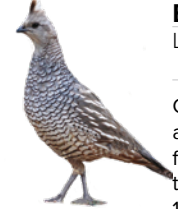

Blue Scale
Ground dweller and native to desert grasslands and thorn scrub. Females can be distinguished from the adult male by the dark shaft streaks on the side of the face and throat. Adults are 9.5" to 12.25" in length. 6-7 oz live weight at 6 weeks.

LQ105 Eggs	30 - 49	\$2.60
	50+	\$2.30



California Valley
Lives in semi-desert sage brush areas, dominated by grasslands. Females have a smaller comma shaped crest than the male. Adults are 9.5" to 10.5" in length. 6.2 oz live weight.

LQ204 Chicks	100-199	\$5.00
	200+	\$4.60
LQ106 Eggs	30 - 49	\$2.60
	50+	\$2.30



Gambel
Similar to the California Valley Quail, this breed has a different color pattern on the breast and sides. Habitat is desert valleys, upland desert, and river basins. Adults are approximately 11" in length.

LQ202 Chicks	100-199	\$5.00
	200+	\$4.60
LQ107 Eggs	30 - 49	\$2.60
	50+	\$2.30



Tennessee Red
This breed is a mutation of the Bobwhite Quail! Larger than the Bobwhite, it is used for meat purposes. Origin: Tennessee. Adults are 9.5" to 10.5" in length. 10-12 oz live weight.

LQ203 Chicks	100-199	\$2.90
	200+	\$2.70
LQ102 Eggs	30 - 49	\$1.90
	50+	\$1.70



Blonde
Fertile quail eggs that are a lighter brown, almost red, color. This breed will be great egg layers and great for meat production. 9-13 oz live weight.

LQ122 Eggs	6 - 23	\$3.65
	24+	\$2.85



Standard Japanese
Excellent meat production and prolific egg layers! Typically quiet and great for dog training! Known as Pharaoh quails. Assorted colors breeders choice.

LQ251 Chicks	25 - 49	\$4.35
	50 - 99	\$2.90
	100+	\$2.50
LQ108 Eggs	6 - 23	\$3.35
	24+	\$2.85



Texas A&M
Fertile quail eggs. This breed is a white skinned, white meat quail, developed for meat production. 12-14 oz live weight.

LQ116 Eggs	6 - 23	\$3.60
	24+	\$2.85



Italian
Fertile quail eggs. This breed will have black and tan markings over cream base. Similar in appearance to the Mexican Speckled Quail. 8-10 oz live weight.

LQ112 Eggs	6 - 23	\$3.65
	24+	\$2.85



Chinese Button Quail Assortment
Breeder's choice assortment of fertile quail eggs. Fast-growing variety. Size of bumblebees when hatched.

LQ114 Eggs	6 - 23	\$3.65
	24+	\$2.85



Jumbo Coturnix Quail
A great option if you don't have much room! They are easy keepers, grow quickly, and are fun to raise. These birds are a great option to provide both meat and eggs for your family.

LQ220 Chicks	25-49	\$4.35
	50-99	\$2.90
	100+	\$2.50



Celadon Coturnix Quail
These Coturnix Quail lay blue eggs. These birds come in a variety of colors. What a great combination to add to your flock!

LQ225 Chicks		\$4.75
--------------	--	---------------



Coturnix Quail Assortment
Breeder's choice assortment of fertile quail eggs. A combination of any of the Japanese Quail types with at least three varieties in any group.

LQ113 Eggs	6 - 23	\$3.65
	24+	\$2.85

Prices include shipping!

Eggs for Hatching

Standard Chicken Hatching Eggs					
Breed	SKU #	Breed	SKU #	Breed	SKU #
Easter Egger	LC001	White Leghorn	LC022	White Broiler	LC031
Black Copper Marans	LC002	Buff Orpington	LC024	Olive Egger	LC034
Black Australorp	LC005	Light Brahma	LC025	Cream Legbar	LC035
Light Brown Leghorn	LC014	Rhode Island Red	LC026	Buff Brahma	LC082
White Cochin	LC015	Barred Plymouth Rock	LC027	Partridge Cochin	LP213
Buckeye	LC021	Welsummer	LC030		
6-15 Eggs		16-25 Eggs		26-49 Eggs	
\$7.00		\$6.50		\$6.00	
Assorted Standard Chicken Hatching Eggs - LC003					
6-15 Eggs		16-25 Eggs		26-49 Eggs	
\$6.00		\$5.50		\$5.00	

Bantam Chicken Hatching Eggs					
Breed	SKU #	Breed	SKU #	Breed	SKU #
Easter Egger	LC006	Green Queen	LC032	Porcelain Belgian Bearded d'Uccle	LC078
Mille Fleur Belgian Bearded d'Uccle	LC010	Mottled Cochin	LC033	White Crested Black Polish	LC099
Assorted Silkies	LC011	Black Frizzle Cochin	LC049		
6-15 Eggs		16-25 Eggs		26-49 Eggs	
\$7.00		\$6.50		\$6.00	
Assorted Bantam Chicken Hatching Eggs - LC004					
6-15 Eggs		16-25 Eggs		26-49 Eggs	
\$6.00		\$5.75		\$5.50	

Duck Hatching Eggs				
Breed	SKU #	Price		
		1-29 Eggs	30-124 Eggs	125-299 Eggs
Buff	LE208	\$8.50	\$6.60	\$5.55
Black Swedish	LE228	\$8.50	\$6.60	\$5.55
Black Runner	LE213	\$9.05	\$7.10	\$5.95
Blue Runner	LE214	\$9.05	\$7.10	\$5.95
Blue Swedish	LE216	\$8.50	\$6.60	\$5.55
Cayuga	LE209	\$8.50	\$6.60	\$5.55
Chocolate Runner	LE215	\$9.05	\$7.10	\$5.95
White Crested	LE217	\$10.45	\$8.25	\$6.90
Fawn & White Runner	LE210	\$9.05	\$7.10	\$5.95
Khaki Campbell	LE211	\$8.30	\$6.45	\$5.40
Mallard	LE203	\$8.50	\$3.40	\$3.65
Mix	LE206	\$6.70	\$5.05	\$4.25
Pekin	LE207	\$7.95	\$6.10	\$5.15
Rouen	LE212	\$8.30	\$6.40	\$5.35

Peachicks **Not Sexed Only**

We offer many colors of Adult Peafowl. Give us a call for pricing and shipping quotes.

Black Shoulder Peafowl



Blue India Peafowl



Purple Peafowl



Silver Pied Peafowl



Pied Peafowl



White Peafowl



Spalding Peafowl



8 Assorted Peachicks - Breeder's Choice

LE300

\$529.95

Get a great assortment of peachicks! Breeders choice of 2-3 colors from: Blue India, Pied, Purple, White or Black Shouldered. More rare but can include: Cameo, Oaten, Silver Pied, Buff Spalding, Midnight, Java, White Spalding or Purple Black Shouldered.

4 Peachicks & 15 Fancy Keets - Assorted

LE501

\$375.00

Get an assortment of peachicks and keets to add to your flock!

4 Peachicks & 15 Keets - Assorted

LE500

\$364.00

Get a perfect mix of these popular birds! Hatchery's choice selection.

Prices include shipping!

Adult Birds

Availability of these birds varies, please call for details. Certain birds, such as pheasants and other migratory birds, may require a permit. Contact your state wildlife management department for information. We are unable to export birds or eggs. Shipping is NOT included in the price of adult birds. Mature birds can be shipped directly to your local post office via EXPRESS MAIL.



Red Golden Pheasant

LA202 Juvenile Pair	\$190.00
LA201 Full Color Pair	\$225.00

Extremely popular full-color aviary bird! Does well in small aviaries and are very hardy. Multiple mutations have occurred, such as the dark throated, Salmon, and the yellow golden. Full plumage in the second year. Clutch: 6-12 eggs. Incubation: 22 days. Sold in pairs only.



Lady Amherst Pheasant

LA206 Juvenile Pair	\$210.00
LA207 Full Color Pair	\$225.00

Uncommon bird with beautiful plumage! Males are 47" in length (31.5" are just for it's tail!) Has a white black cape and a red crest, tail and rump are gray with red, blue, dark green, white, and yellow plumage. Females are 24-26" its length and have a dull brown mottled plumage with fine barring all over and a darker head. Females lay 5-12 eggs. Incubation: 22 days. Sold in pairs only.



Yellow Golden Pheasant

LA205 Juvenile Pair	\$190.00
LA204 Full Color Pair	\$225.00

Aviary bird variety of the Red Golden. Does well in small aviaries and are very hardy. Has light yellow feathers. Males have a bright golden crest. Upper back is a dark metallic green with black borders, the rest of the back and rump have golden feathers. Central tail feathers are black and spotted with buff. Full plumage in second year. Females are 25" in length. Males are 39" in length. Clutch: 6-12 eggs. Incubation: 22-23 days. Female weight: 1.35 lbs. Male weight: 1.5 lbs. Sold in pairs only.



Grey Peacock Pheasant

LA220 Full Color Pair	\$825.00
-----------------------	-----------------

Males are 29", grayish birds with iridescent blue-green ocelli (eyespot) on their wings and tail feathers. Females are much smaller and not as colorful as males. Can be tame and aren't usually aggressive with each other. The hens make good mothers and can hatch their own eggs. Large aviary not required, they need access to shade in the summer months and require shelter and heat in the colder months. Sold in pairs only.



Reeves Pheasant

LA211 Juvenile Pair **\$190.00**
 LA231 Full Color Pair **\$225.00**

Large pheasant with a beautiful color pattern. Male has a white crown with a black band. Plumage the first year. Females are 30" L. Males are 84" L. Includes tail. Clutch size: 7-14 eggs. Incubation: 25 days. Female weight: 2.1 lb. Male weight: 3.3 lb. Sold in pairs only.



Silver Pheasant

LA213 Juvenile Pair **\$190.00**
 LA212 Full Color Pair **\$225.00**

Under 1 year of age and are not fully colored. Full coloration will take at least 2 years, but can be fertile in the first year. Sold in pairs only.



Swinhoe Pheasant

LA210 Juvenile Pair **\$190.00**
 LA230 Full Color Pair **\$225.00**

Calm pheasant that is great for beginners! Juveniles are younger than 1 year old. Full plumage occurs at 2 years old. Males are 31" L. Very hardy and adaptable. Females lay 3-7 eggs. Incubation: 24-27 days. Sold in pairs only.

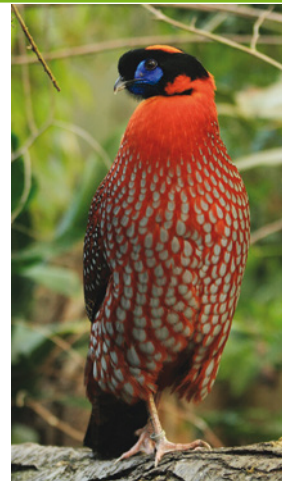

Temminck Tragopans

LP181 Juvenile Pair **\$825.00**



Wood Duck

LA115 Juvenile Pair **\$265.00**



Mandarin Duck

LA106 Juvenile Pair **\$265.00**

A stunning addition to any pond! Males have a very striking marking with a red bill and a large white crescent above the eye. Females have a pale beige with thin white flank strip and closely resemble a female wood duck.



White Mute Swans

LA503 Young Pair **\$2,775.00**
 LA501 Breeder Pair **\$3,750.00**

A natural addition to any pond! Swans spend most of their time floating on the water, grazing on underwater vegetation in shallow waters. Sold in pairs only.



Black Australian Swans

LA504 Young Pair **\$2,775.00**
 LA505 Breeder Pair **\$3,750.00**

The blackish plumage makes this species unmistakable from any other swan! In flight, the white flight feathers contrast strongly with the black plumage. Clutch size: 4-10 eggs, laid on alternate days. Breeding starts at 2-3 years. Sold in pairs only.



Trumpeter Swans

LA507 Young Pair **\$3,750.00**
 LA500 Breeder Pair **\$5,250.00**

This majestic bird will be a great addition to any pond! Swans spend most of their time floating on the water, grazing on underwater vegetation in shallow waters. Breeding starts at 2-3 years. Sold in pairs only.



Whooper Swans

LA506 Young Pair **\$3,750.00**

A beautiful addition to any pond! They spend most of their time floating on the water, grazing on underwater vegetation in shallow waters. These gorgeous birds will add so much beauty to your landscape! Sold in pairs only.



East African Crane

LA616 Juvenile Pair **\$4,500.00**

Named for the distinctive, bristle-like, golden feathers on top of their black head. Watch them bob and weave while they dance! Crowned cranes stand 44-48" tall; males are slightly taller on average. Weight: 6-8 lbs. Wingspan: 6.5 ft.



Utility Pigeons (Squab)

Sexing guaranteed for 6 weeks from purchase.



Giant Runt Utility Pigeon Shipping Rates

Quantity ordered	1 Pair or 1-2 birds	2 Pairs or 3-4 birds	3 Pairs or 5-6 birds	4 Pairs or 7-8 birds
Add per order	\$127.50	\$255.00	\$382.50	\$510.00

Shipping is not included. Add shipping rates to your total order. Pigeons ship via USPS Express

Giant Runt Utility Pigeons

LD227 Pair	\$195.00
LD827 Female	\$105.00
LD627 Male	\$105.00

Largest and oldest of all domestic pigeons! Excellent utility pigeon with a large body size and wing span. Bred for utility purposes, not show type. Young non-mated pigeons have not been flown. Banded. Sold at 3-18 months of age. Weight: 2-2.5 lbs.



White King Utility Pigeons

LD205 Pair	\$150.00
LD805 Female	\$80.00
LD605 Male	\$80.00

Primarily bred for meat and are not show type. Adults are fertile and very productive. Weight: 25 oz. Age: 3-18 months.



Giant White Hubble Utility Pigeons

LD300 Pair	\$180.00
LD900 Female	\$95.00
LD700 Male	\$95.00

White King & Giant White Hubble Utility Pigeons Shipping Rates

Quantity ordered	1 Pair or 1-2 birds	2 Pairs or 3-4 birds	3 Pairs or 5-6 birds	4 Pairs or 7-8 birds
Add per order	\$127.50	\$152.50	\$280.00	\$305.00

Shipping is not included. Add shipping rates to your total order. Pigeons ship via USPS Express

Fantail Pigeons

Sexing guaranteed for 6 weeks from purchase.



Black Indian Fantail

LD267 Pair	\$225.00
LD867 Female	\$120.00
LD667 Male	\$120.00

Strikingly beautiful color. May have some white coloration.
Ages 3-18 months



Snow White Indian Fantail

LD289 Pair	\$210.00
LD889 Female	\$110.00
LD689 Male	\$110.00

Fancy breed with beautiful snow white coloring! Breeds easily.
Ages 3-18 months



Indian Fantail

LD268 Pair	\$150.00
LD868 Female	\$80.00
LD668 Male	\$80.00

Known for being a beautiful and fancy breed! Breeds easily.
It comes splashed or muffed. The color selection is breeder's choice.
Ages 3-18 months



Red Fantail

LD206 Pair	\$135.00
LD806 Female	\$75.00
LD606 Male	\$75.00

A beautiful addition to a loft! They do well in lofts versus breeding cages. This breed is not the Indian Fantail variety.
Ages 3-18 months



Black Fantail

LD203 Pair	\$150.00
LD803 Female	\$80.00
LD603 Male	\$80.00

Exhibition breed that can have some white coloration. Sexually mature at 6 months. This breed is not the Indian Fantail variety.
Clutch size: 2 eggs. About 6 clutches per year. Incubation: 18 days.
Ages 3-18 months



Splashed Fantail

LD207 Pair	\$135.00
LD807 Female	\$75.00
LD607 Male	\$75.00

Exhibition breed that is sexually mature at 6 months. Clutch size: 2 eggs. About 6 clutches per year. Not mated. Incubation: 18 days.
Weight: 14-18 oz. Ages 3-18 months



White Fantail

LD200 Pair	\$150.00
LD800 Female	\$80.00
LD600 Male	\$80.00

Exhibition breed that is sexually mature at 6 months. Clutch size: 2 eggs. About 6 clutches per year. Incubation: 18 days. Weight: 14-18 oz. Ages 3-18 months

Fantail Pigeon Shipping Rates				
Quantity ordered	1 Pair or 1-2 birds	2 Pairs or 3-4 birds	3 Pairs or 5-6 birds	4 Pairs or 7-8 birds
Add per order	\$122.50	\$147.50	\$270.00	\$295.00

Show Pigeons

Sexing guaranteed for 6 weeks from purchase.



Gold Black Wing Angel

LD278	Pair	\$135.00
LD878	Female	\$75.00
LD678	Male	\$75.00

Rich-colored pigeon with a magnificent green sheen and iridescence! Age: 3-18 months.



Black Lace Classic Old Frill Satinette

LD282	Pair	\$135.00
LD882	Female	\$75.00
LD682	Male	\$75.00

Beautiful pigeon with a boldly-marked color pattern. Calm and friendly. Breeds easily and raises its own young well. Age: 3-18 months.



Bluet Classic Old Frill Satinette

LD281	Pair	\$135.00
LD881	Female	\$75.00
LD681	Male	\$75.00

A cute and friendly, calm breed with great coloration! Breeds easily and raises its own young well. Age: 3-18 months.



Blue Lace Classic Old Frill Satinette

LD280	Pair	\$135.00
LD880	Female	\$75.00
LD680	Male	\$75.00

A beautiful and friendly calm breed with fantastic color. Breeds easily and raises its own young well. Age: 3-18 months.

Show Pigeons (Can be shipped with Rollers, Tumblers, & Racing Homers)					
Quantity ordered	1 Pair or 1-2 birds	2 Pairs or 3-4 birds	3 Pairs or 5-6 birds	4 Pairs or 7-8 birds	5-6 Pairs or 9-12 birds
Add per order	\$122.50	\$137.50	\$147.50	\$275.00	\$295.00



Black Chinese Owl Pigeon

LD288	Pair	\$225.00
LD888	Female	\$120.00
LD688	Male	\$120.00

Beautiful color. May have some white coloration.
Age 3 - 18 months



Blue Lace Blondinette Classic Old Frill

LD246	Pair	\$135.00
LD846	Female	\$75.00
LD646	Male	\$75.00

Tame, friendly, and intelligent birds with beautiful coloration! Raises its own young well. Age 3 - 18 months



Black Lace Blondinette Classic Old Frill

LD291	Pair	\$135.00
LD891	Female	\$75.00
LD691	Male	\$75.00

Tame, friendly, and intelligent birds with beautiful coloration! Has rare beautiful black lacing. Age 3 - 18 months



Red Lace Blondinette Classic Old Frill

LD292	Pair	\$135.00
LD892	Female	\$75.00
LD692	Male	\$75.00

Tame, friendly, and intelligent birds with fantastic coloration! Age 3 - 18 months



Blondinette Classic Old Frill

LD208	Pair	\$135.00
LD808	Female	\$75.00
LD608	Male	\$75.00

Age: 3-12 months. Breeder's choice of assorted colors. Age 3 - 18 months



Brunette Brown Lace Classic Old Frill

LD301	Pair	\$135.00
LD901	Female	\$75.00
LD701	Male	\$75.00

Age 3 - 18 months



Black White Bar Starling

LD283	Pair	\$135.00
LD883	Female	\$75.00
LD683	Male	\$75.00

Gorgeous gloss with a beautiful, intense, rich color! Age 3 - 18 months



Chinese Owl

LD217	Pair	\$135.00
LD817	Female	\$75.00
LD617	Male	\$75.00

Known for being tame and friendly! Easy to breed and raise their own young. Breeder's choice color, ranging from red, blue, and splash. Age 3 - 18 months



White Chinese Owl

LD290	Pair	\$180.00
LD890	Female	\$95.00
LD690	Male	\$95.00

Beautiful, small white bird that is known for being tame and friendly! Easy to breed and raise their own young. Age 3 - 18 months

Roller & Tumbler Pigeons

Sexing guaranteed for 6 weeks from purchase.



Old English Tumbler

LD216 Pair	\$135.00
LD816 Female	\$75.00
LD616 Male	\$75.00

Muffed and saddle marked. Very acrobatic breed. Smaller body size enables bird to roll and tumble more readily. Breeder's choice of black, yellow, and red. Adult size: 6-7 oz. Age: 3-18 months.



Portuguese Tumbler

LD273 Pair	\$120.00
LD873 Female	\$65.00
LD673 Male	\$65.00

Tiny, cute, and friendly birds! Breeder's choice. Assorted colors. Age: 3-18 months.



Extreme Velocity Birmingham Roller Grand Children

LD244 Pair	\$180.00
LD844 Female	\$95.00
LD644 Male	\$95.00

This breed is fast, frequently spins, and has a great style! First place winner. Grand Champion 2007 Single Bird Futurity Competition Fly in Virginia. Inbred and is mated to her full brother. Will roll 35'. Age: 3-18 months.



Grand Champion Flying Roller

LD285 Pair	\$270.00
LD286 Female	\$140.00
LD287 Male	\$140.00

This family won the U.S. Grand National Championship Flying Competition for both the 20 bird team and the 11 bird team in 2019. Age: 3-18 months.

Rollers & Tumblers Pigeon Shipping Rates (Can be shipped with Show, & Racing Homers)					
Quantity ordered	1 Pair or 1-2 birds	2 Pairs or 3-4 birds	3 Pairs or 5-6 birds	4 Pairs or 7-8 birds	5-6 Pairs or 9-12 birds
Add per order	\$122.50	\$137.50	\$147.50	\$275.00	\$295.00

Shipping is not included. Add shipping rates to your total order. Pigeons ship via USPS Express



Silver Birmingham Roller

LD270 Pair	\$135.00
LD870 Female	\$75.00
LD670 Male	\$75.00

Flying type and great spinners! Age 3 - 18 months



Black Birmingham Roller

LD235 Pair	\$135.00
LD835 Female	\$75.00
LD635 Male	\$75.00

Flying type and great spinners! Birds stop mid-flight and roll downward. Come in a solid or splashed color based on the Breeder's choice. Age 3 - 18 months



Snow White Birmingham Roller

LD215 Pair	\$135.00
LD815 Female	\$75.00
LD615 Male	\$75.00

Flying type and great spinners! Birds stop mid-flight and roll downward. Some birds may have colored ticking on the head or neck. Age 3 - 18 months



Blue Bar Birmingham Roller

LD271 Pair	\$135.00
LD871 Female	\$75.00
LD671 Male	\$75.00

Great deep spinner and flying type! Smaller birds. Age 3 - 18 months



Red Birmingham Roller

LD236 Pair	\$135.00
LD836 Female	\$75.00
LD636 Male	\$75.00

Flying type and great spinners! Come in a solid red or splashed color pattern based on the Breeder's choice. Age 3 - 18 months



Yellow Birmingham Roller

LD220 Pair	\$135.00
LD820 Female	\$75.00
LD620 Male	\$75.00

Flying type and great spinners! Come in a solid or splashed color based on the Breeder's choice. Age 3 - 18 months





Alfons Klaas

LD254 Pair	\$210.00
LD854 Female	\$110.00
LD654 Male	\$110.00
LD257 Racing Team - Pedigreed	\$525.00

Great, young bird racers! Imported from Germany's world famous loft, Alfons Klaas, which has won the Sun City Million Dollar Pigeon Race in 2007 and 2011. They are fast, hard charging, and intelligent. Limited supply. Age: 3 - 18 months



Aarden

LD225 Pair	\$180.00
LD825 Female	\$95.00
LD625 Male	\$95.00
LD252 Racing Team - Pedigreed	\$450.00

Fast and excellent homing ability! Age: 3 - 18 months



Verkerk

LD229 Pair	\$180.00
LD829 Female	\$95.00
LD629 Male	\$95.00
LD239 Racing Team - Pedigreed	\$480.00

Excels in futurity races, especially in races from 300 to 400 miles. Sleek, fast, and intelligent! Age: 3 - 18 months



Huysken Van Riel

LD232 Pair	\$180.00
LD832 Female	\$95.00
LD632 Male	\$95.00
LD240 Racing Team - Pedigreed	\$480.00

Fast, reliable winners from 100 to 500 miles! Age: 3 - 18 months



Van De Pasch

LD233 Pair	\$195.00
LD833 Female	\$105.00
LD633 Male	\$105.00
LD243 Racing Team - Pedigreed	\$480.00

This breed is the cutting edge technology in racing homers! Great racers from 100 to 500 miles. Beautiful, sleek, fast, and highly intelligent! Age: 3 - 18 months



C & G Koopman

LD250 Pair	\$210.00
LD850 Female	\$110.00
LD650 Male	\$110.00
LD251 Racing Team - Pedigreed	\$525.00

World famous loft winners from the Netherlands! From the Kannibal & Kleine Dirk family. Third Generation. These birds are the cutting edge technology in Racing Homers. 400 miles per day. Age: 3 - 18 months



Janssen

LD214 Pair	\$135.00
LD814 Female	\$75.00
LD614 Male	\$75.00
LD237 Racing Team - Not Pedigreed	\$405.00

Can fly 400-500 miles at around 55 mph. Highly intelligent. Origin: Europe, Germany/Belgium.



Red Check Janssen

LD263 Pair	\$150.00
LD863 Female	\$80.00
LD663 Male	\$80.00
LD304 Racing Team - Not Pedigreed	\$450.00

Great for futurity and one loft racing! Fast and intelligent. Available in teams, as well.



Silver Janssen

LD295 Pair	\$210.00
LD895 Female	\$110.00
LD695 Male	\$110.00
LD296 Racing Team - Not Pedigreed	\$480.00

Comes from the finest young bird racing stock available! Great for futurity and one loft racing. Fast, sleek, and highly intelligent. Great eye sight.

Race Teams include 6, not sexed, approximately 5-week-old, banded birds. All race teams are Pedigreed except Janssens. You cannot mix breeds within a team. Shipping for each Race Team is \$155.00 per team. See page 137 for complete Racing Homer shipping rates.

The fastest way to get homing pigeons to your loft!

Sexing guaranteed for 6 weeks from purchase.



Milky Powder Blue

LD293 Pair	\$225.00
LD893 Female	\$120.00
LD693 Male	\$120.00

Great show-type bird! Bred for refinement and structure! Strikingly beautiful powdery-blue color. New in 2018.

Age: 3 - 18 months



Jelle Rozier's

LD303 Pair	\$240.00
LD903 Female	\$125.00
LD703 Male	\$125.00

Belgium's New National Young bird specialist! Winning 16 national and zone top 10 prizes in the last 6 years. Bred out of the famous Queen L line!

Age: 3 - 18 months



Gold Rush

LD209 Pair	\$420.00
LD809 Female	\$215.00
LD609 Male	\$215.00

First place winner at 2016 GLF race. Grand Champion won \$10,000 at 400 miles, beating the next pigeon in the race by 6 full minutes. Direct children of "Gold Rush" come with pedigree.

Age: 3 - 18 months



Fast Gold

LD260 Pair	\$420.00
LD860 Female	\$215.00
LD660 Male	\$215.00

Direct children of "Fast Gold"! Fast Gold was the first place winner at the 2015 GBC Classic Young Bird Futurity Race. Also won Grand Champion, being the fastest bird in the race. "Fast Gold" won \$10,000 in a 350 mile race.

Age: 3 - 18 months



De Rauw Sablon

LD253 Pair	\$270.00
LD853 Female	\$140.00
LD653 Male	\$140.00
LD256 Racing Team - Pedigreed	\$585.00

Cutting edge technology in racing pigeons! They dominate middle and long distance racing in Belgium. Known for breeding and racing success. They have won first National Awards in 2003, 2005, 2006, and 2009.

Age: 3 - 18 months



Gaby Vandenebee

LD230 Pair	\$180.00
LD830 Female	\$95.00
LD630 Male	\$95.00
LD241 Racing Team - Pedigreed	\$480.00

Cutting edge technology in racing homers! Imported from Belgium stock. "Den Wittenbuik" family. Winners of many first place prizes worldwide. Excellent homers from 60 to 500 miles.

Age: 3 - 18 months



Van Loon

LD234 Pair	\$180.00
LD834 Female	\$95.00
LD634 Male	\$95.00
LD238 Racing Team - Pedigreed	\$450.00

Fast and quickly maturing sprint birds! Can fly up to 400 miles and have excellent homing ability. Color and appearance may vary. Young non-mated pigeons that have not been flown. Banded.

Age: 3 - 18 months



5 Grand

LD261 Pair	\$420.00
LD861 Female	\$215.00
LD661 Male	\$215.00

First place winner at 2016 WCR young bird futurity race. Grand champion, fastest bird in the race for a prize of \$5,000 at 350 miles. Direct children of "5 Grand".

Age: 3 - 18 months



Bordeaux

LD231 Pair	\$180.00
LD831 Female	\$95.00
LD631 Male	\$95.00
LD242 Racing Team - Pedigreed	\$480.00

Great for extreme long distance of 500 miles and beyond!

Age: 3 - 18 months

Sexing guaranteed for 6 weeks from purchase.



Black Eagle Saddle

LD219	Pair	\$150.00
LD819	Female	\$80.00
LD619	Male	\$80.00

Age: 3-18 months.



Golden Peach

LD224	Pair	\$900.00
LD824	Female	\$455.00
LD624	Male	\$455.00

A two-time winner of first place at the Peach Classic. Coming in first place at 150 miles and 200 miles. These birds are direct children of the Gold Peach and Come with a Pedigree. Age: 3-18 months.



Snow White Trenton

LD201	Pair	\$135.00
LD801	Female	\$75.00
LD601	Male	\$75.00

All white pigeons that can be a successful long distance flight breed with proper training. Young, non-mated pigeons that have not been flown. Banded. Age: 3-18 months.



Opal White Bar Saddle

LD222	Pair	\$135.00
LD822	Female	\$75.00
LD622	Male	\$75.00

Intelligent and friendly breed that is uniquely marked!
Age: 3-18 months.



Black Eagle

LD211	Pair	\$150.00
LD811	Female	\$80.00
LD611	Male	\$80.00

Strong and reliable long distance flyers! Slightly larger than the other homer breeds with powerful wings. Origin: South Africa. Age: 3-18 months.



Sexing guaranteed for 6 weeks from purchase.



Blue Bar Saddle Janssen

LD223 Pair	\$135.00
LD823 Female	\$75.00
LD623 Male	\$75.00

Fast, quick maturing, and reliable racing homer! Well-conditioned birds. Can fly 400-500 miles. Light bluish gray color with two black bars across the back part of the top surface of the wing. Origin: Europe, Germany/Belgium. Age: 3-18 months.



Yellow Trenton

LD210 Pair	\$150.00
LD810 Female	\$80.00
LD610 Male	\$80.00

Smart birds and powerful flyers! Parent stock has flown up to 400 miles in homer races. To keep yellow color, two yellow trentons need to mate. Age: 3-18 months.



Bandit

LD226 Pair	\$150.00
LD826 Female	\$80.00
LD626 Male	\$80.00

Strong flyers with beautiful blue grizzled (black flecks in the feathers) splashed! The breeder's flock are direct descendants of a famous racing pigeon named "Bandit". Age: 3-18 months.



Red Saddle Meuleman

LD218 Pair	\$135.00
LD818 Female	\$75.00
LD618 Male	\$75.00

Intelligent and fast long distance flyers! Young, non-mated pigeons that have not been flown. Banded. Age: 3-18 months.

The fastest way to get homing pigeons to your loft!

acing Homer Pigeons Shipping Rates (Can be shipped with Rollers, Show, & Tumblers)					
Quantity ordered	1 Pair or 1-2 birds	2 Pairs or 3-4 birds	3 Pairs or 5-6 birds	4 Pairs or 7-8 birds	5-6 Pairs or 9-12 birds
Add per order	\$122.50	\$137.50	\$147.50	\$275.00	\$295.00

Shipping is not included. Add shipping rates to your total order. Pigeons ship via USPS Express

Diamond Doves

Sexing guaranteed for 6 weeks from purchase.

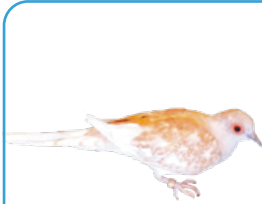

Ultimate Red

LD118	Pair	\$150.00
LD518	Female	\$80.00
LD418	Male	\$80.00

The smallest of all doves! Red with white background. Age: 3-18 months.



Brilliant

LD117	Pair	\$325.00
LD517	Female	\$170.00
LD417	Male	\$170.00

Very striking and beautiful color pattern! Age: 3-18 months.

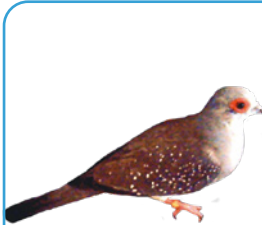

Blue (Normal)

LD101	Pair	\$120.00
LD501	Female	\$65.00
LD401	Male	\$65.00

Ideal for beginners! This breed is the normal, or wild color. Age: 3-18 months.



Blue White Tail

LD125	Pair	\$120.00
LD525	Female	\$65.00
LD425	Male	\$65.00

Ground feeders that can do well in an aviary with finches! Both parents incubate. Incubation: Around 13 days. Age: 3-18 months.



Blue White Tail Laced

LD115	Pair	\$120.00
LD515	Female	\$65.00
LD415	Male	\$65.00

A striking variation of the usual Diamond dove color pattern! Age: 3-18 months.



Silver

LD120	Pair	\$180.00
LD520	Female	\$95.00
LD420	Male	\$95.00

The original color mutation in the silver family! Ideal for beginners. Age: 3-18 months.

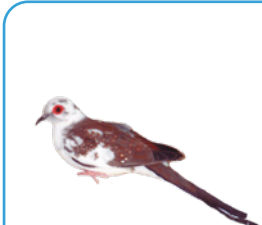

Blue Pied

LD124	Pair	\$150.00
LD524	Female	\$80.00
LD424	Male	\$80.00

Ground feeders that will do well in an aviary with finches! Both parents incubate. Incubation: Around 13 days. Age: 3-18 months.



Red Pied

LD157	Pair	\$300.00
LD557	Female	\$155.00
LD457	Male	\$155.00

Age: 3-18 months.



Silver White Tail

LD119	Pair	\$180.00
LD519	Female	\$95.00
LD419	Male	\$95.00

Very light bird. Young birds appear completely white but get slightly darker as they mature. Age: 3-18 months.



Brilliant White Tail

LD136	Pair	\$290.00
LD538	Female	\$150.00
LD438	Male	\$150.00

An extremely rare and beautiful color in Diamond Doves! It appears to be almost snow white. Age: 3-18 months.



Red

LD112	Pair	\$120.00
LD512	Female	\$65.00
LD412	Male	\$65.00

The male displays less rust-red and more silver on the back, shoulders, and wings in comparison to the hen. The female displays much more of the rust-red coloration. Not banded or mated. Age: 3-18 months.



Blue White Tail Pied Lightly Marked

LD123	Pair	\$150.00
LD523	Female	\$80.00
LD423	Male	\$80.00

Age: 3-18 months.



Yellow

LD111	Pair	\$120.00
LD511	Female	\$65.00
LD411	Male	\$65.00

Shoulders, back, wings, and tail are a pale dandelion yellow. Light, purple-silver head, neck, and breast. White underside. The eyes are ruby-red with a bright red-orange eye ring. Black-gray beak. Not banded or mated. Age: 3-18 months.



Peach

LD122	Pair	\$120.00
LD522	Female	\$65.00
LD422	Male	\$65.00

Strikingly beautiful and different color pattern than that of the Yellow Diamond Dove. The head, neck, breast, back, shoulders, wings, and tail display a faded, light yellow dandelion color. Ideal for beginners. 7-8" in length. Lifespan: 8-12 years. Age: 3-18 months.



Blue White Rump

LD100	Pair	\$120.00
LD500	Female	\$65.00
LD400	Male	\$65.00

A steel-blue color is displayed on the shoulders and back. The shoulders have white diamond spots. Light silver-blue head, neck, and breast. Both parents will incubate the eggs. Age: 3-18 months.



Cinnamon

LD139	Pair	\$120.00
LD539	Female	\$65.00
LD439	Male	\$65.00

The most basic form of red in Diamond doves. All of the red and ultimate red mutations began with Cinnamon. It displays a rust-red coloration on the shoulders and wings. Age: 3-18 months.



Yellow White Tail

LD113	Pair	\$150.00
LD513	Female	\$80.00
LD413	Male	\$80.00

Ground feeders that will do well in an aviary with finches. Very pale, yellow dandelion color on the shoulders, wings, head, neck, and breast. Not banded or mated. Both parents incubate. Incubation: Around 13 days. Age: 3-18 months.



Super White Blue White Tail Pied

LD160	Pair	\$375.00
LD161	Female	\$195.00
LD162	Male	\$195.00

Age: 3-18 months.

Diamond Dove Shipping Rates (Cannot be combined with other bird categories)			
Quantity ordered	1 Pair or 1-2 birds	2-3 Pairs or 3-6 birds	4 Pairs or 7-8 birds
Add per order	\$117.50	\$122.50	\$142.50

Shipping is not included. Add shipping rates to your total order. Pigeons ship via USPS Express

Ringneck Doves

No sexing guarantee, however our breeder strives for 95% accuracy!

Snow White

LD103	Pair	\$100.00
LD503	Female	\$55.00
LD403	Male	\$55.00



White body, tail, wing, and head. May have a slight cream color at the underside of the tail as well as a light-colored neck ring. Orange eye color. Weight: 4.5 oz. Age 3-18 months.

Orange

LD143	Pair	\$100.00
LD543	Female	\$55.00
LD443	Male	\$55.00



Intense peach-rust-orange color on the body, head, and wings. The main distinction is the gray to white neck ring and white flight feathers. Deep red eye color. Weight: 4.5 oz. Age 3-18 months.

Snow White Silky

LD104	Pair	\$100.00
LD504	Female	\$55.00
LD404	Male	\$55.00



Like other ringneck dove varieties, though there's a drastic difference in the feathering. The inner web of the feathers is connected to the feather shaft, but the outer web is not. This causes their silky effect. Weight: 4.5 oz. Age 3-18 months.

Albino

LD140	Pair	\$100.00
LD540	Female	\$55.00
LD440	Male	\$55.00



Whitest and brightest dove! Eye color can vary from pinkish to pinkish orange. Younger birds may have slightly different shade than at their mature age of 6-8 months. Very tame. Age 3-18 months.

Tangerine Pearl

LD114	Pair	\$100.00
LD514	Female	\$55.00
LD414	Male	\$55.00



Intense rusty-red colored body. Violet head, neck, and breast. White flights, tail, and neck ring. The white feathers are tipped with tangerine, giving a pearl effect. Age 3-18 months.

Violet Neck

LD105	Pair	\$120.00
LD505	Female	\$65.00
LD405	Male	\$65.00



Has a white body, wings, and tail. Can have traces of tangerine or orange pearling on the back and shoulders. Violet color is most pronounced as adults. Can have a white 'cap' on the top of the head. Weight: 4.5 oz. Age 3-18 months.

Rosy

LD145	Pair	\$100.00
LD545	Female	\$55.00
LD445	Male	\$55.00



Darker red or orange than the Peach Ring neck. Violet head, neck, and breast. Black neck ring. Deep red eye color. Brownish tail bar. Age 3-18 months.

Orange Pied

LD108	Pair	\$100.00
LD508	Female	\$55.00
LD408	Male	\$55.00



White body with orange splash. The colors are not combined, but it is a separate mutation. Black eyes. Seed eater. Weight: 4.5 oz. Age 3-18 months.

Peach

LD106	Pair	\$100.00
LD506	Female	\$55.00
LD406	Male	\$55.00



Creamy orange-colored body, wings, tail, and head. The flights are mostly white. Charcoal-colored neck ring. Deep red eye color. Weight: 4.5 oz. Age 3-18 months.

Orange Pearl

LD102	Pair	\$100.00
LD502	Female	\$55.00
LD402	Male	\$55.00



Orange body with white feathers edged or tipped with orange, giving a pearled effect. Seed eater. Weight: 4.5 oz. Age 3-18 months.

Miniature



LD144	Pair	\$100.00
LD544	Female	\$55.00
LD444	Male	\$55.00

Assorted colors. Slightly smaller than regular ring necks, both in length and weight. There will be a size variation, even in the miniatures. Age 3-18 months.

Snow White Miniature



LD155	Pair	\$100.00
LD555	Female	\$55.00
LD455	Male	\$55.00

Age: 3-18 months.

Wild Pied



LD141	Pair	\$100.00
LD541	Female	\$55.00
LD441	Male	\$55.00

Wild-colored but with random patches of white. Pied condition can occur on any color variety. Black eyes. The bill varies from light to dark. Age 3-18 months.

Ash



LD109	Pair	\$180.00
LD509	Female	\$95.00
LD409	Male	\$95.00

Light silver. Extremely diluted gray to white colored body. Seed eater. Males coo, hens do not. Weight: 4.5 oz. Age 3-18 months.

Tangerine



LD142	Pair	\$100.00
LD542	Female	\$55.00
LD442	Male	\$55.00

Intense rusty-red colored body. Head, neck, and breast are violet. Weight: 4.5 oz. Age 3-18 months.

Wild



LD129	Pair	\$100.00
LD529	Female	\$55.00
LD429	Male	\$55.00

Original color pattern. Weight: 4.5 oz. Age 3-18 months.

Rear Crested



LD116	Pair	\$100.00
LD516	Female	\$55.00
LD416	Male	\$55.00

Crests are at the back of the head and tufts are at the front. Seed eater. Breeder's choice of color. Weight: 4.5 oz. Age 3-18 months.

Double Crested



LD133	Pair	\$100.00
LD533	Female	\$55.00
LD433	Male	\$55.00

Tuft on the front of head, crest in back. Assorted colors, breeder's choice. Seed eater. Weight: 4.5 oz. Age 3-18 months.

Bull-Eyed White



LD134	Pair	\$100.00
LD534	Female	\$55.00
LD434	Male	\$55.00

Primary characteristic is super white color with dark eyes. No neck ring. Seed eater. Males coo, hens do not. Weight: 4.5 oz. Age 3-18 months.

Tufted



LD107	Pair	\$100.00
LD507	Female	\$55.00
LD407	Male	\$55.00

Tufted gene causes feathers on the forehead to reverse their normal direction and point forward in a "tuft". Can be any color variety. Weight: 4.5 oz. Age 3-18 months.

Ringneck Dove Shipping Rates (Cannot be combined with other bird categories)			
Quantity ordered	1 Pair or 1-2 birds	2-3 Pairs or 3-6 birds	4 Pairs or 7-8 birds
Add per order	\$117.00	\$122.50	\$142.50

Shipping is not included. Add shipping rates to your total order. Pigeons ship via USPS Express

Exotics

Sexing guaranteed for 6 weeks from purchase.



Triangular Spotted Pigeon

LD262	Pair	\$750.00
LD862	Female	\$380.00
LD662	Male	\$380.00

Large and beautiful exotic pigeon! Cold hardy. Breeds easily. Age 3-18 months.



Australian Crested Dove

LD131	Pair	\$600.00
LD531	Female	\$305.00
LD431	Male	\$305.00

Also known as the Crested Pigeon! Crown gray with long, slender feathers. Cold hardy. 12-14" in length. Age 3-18 months.



Cape (Masked) Dove

LD128	Pair	\$375.00
LD528	Female	\$195.00
LD428	Male	\$195.00

This breed has a very soft cool! Compatible with finches, other small doves, and quail in a large aviary. 7-9" in length. Age 3-18 months.



Palm Turtle Dove

LD156	Pair	\$300.00
LD556	Female	\$155.00
LD456	Male	\$155.00

Beautiful, rich tangerine color! Breeds easily and will raise many young on its own. Age 3-18 months.



Pygmy Ground Dove

LD154	Pair	\$270.00
LD554	Female	\$140.00
LD454	Male	\$140.00

The smallest dove in the world! It is about the size of a finch. Quick flyers! Good breeders. Does well in an aviary setting. Age 3-18 months.



Zebra Dove

LD121	Pair	\$390.00
LD521	Female	\$200.00
LD421	Male	\$200.00

Very flighty and fast-flying birds! Males are aggressive. This breed is slightly larger than Diamond Doves. 9" in length. Age 3-18 months.



Green Wing Dove

LD135	Pair	\$750.00
LD535	Female	\$380.00
LD435	Male	\$380.00

Good parents and breeds well in small cages and large aviaries! Do not house with ring neck doves. 10" in length. Age 3-18 months.

Exotics Shipping Rates (Different breeds cannot ship in the same box.)			
Quantity ordered	1 Pair or 1-2 birds	2-3 Pairs or 3-6 birds	4 Pairs or 7-8 birds
Add per order	\$117.50	\$122.50	\$142.50

Shipping is not included. Add shipping rates to your total order. Pigeons ship via USPS Express

Live Bird Shipping Rates

Hatches are scheduled weekly with the hatchery. Stromberg's is not a hatchery, but we work closely with hatchery partners to ensure that we provide our customers with the highest-quality birds available. Most birds do not have shipping prices included. Please refer to the charts or call our customer service team for shipping rates.

Chicks, Bantam Chicks, and Turkey Shipping Rates (3 bird minimum per order)							
Quantity ordered	3-4 birds	5-14 birds	15-24 birds	25-49 birds	50-99 birds	100-149 birds	150+ birds
Add per bird	Visit www.strombergschickens.com for shipping costs on these birds						

Duck Shipping Rates (2 bird minimum per order)			
Quantity ordered	2-9 birds	10-14 birds	15+ birds
Add per order	\$50.00	\$25.25	\$15.00

Goose Shipping Rates (2 bird minimum per order)			
Quantity ordered	2-4 birds	5-8 birds	9+ birds
Add per order	\$50.00	\$25.25	\$15.00

Adult Light Duck				
Page	Breed	1 Pair	2 Pairs	3 Pairs
126	Mandarin Duckt	\$287.50	\$387.50	\$411.00
126	Wood Duck	\$287.50	\$387.50	\$411.00

Adult Light Pheasants				
Page	Breed	1 Pair	2 Pairs	3 Pairs
125	Grey Peacock Pheasant	\$277.50	\$387.50	\$401.00
125	Lady Amherst Pheasant	\$277.50	\$387.50	\$401.00
125	Red Golden Pheasant	\$277.50	\$387.50	\$401.00
125	Yellow Golden Pheasant	\$277.50	\$387.50	\$401.00

Adult Heavy Pheasants				
Page	Breed	1 Pair	2 Pairs	
126	Reeves Pheasant	\$287.50	\$387.50	
126	Silver Pheasant	\$287.50	\$387.50	
126	Swinhoe Pheasant	\$287.50	\$387.50	
126	Temminck Tragopans	\$287.50	\$387.50	

Rollers, Show, Tumblers, & Racing Homer Pigeons Shipping Rates					
Quantity ordered	1 Pair or 1-2 birds	2 Pairs or 3-4 birds	3 Pairs or 5-6 birds	4 Pairs or 7-8 birds	5-6 Pairs or 9-12 birds
Add per order	\$122.50	\$137.50	\$147.50	\$275.00	\$295.00

Fantail Pigeon Shipping Rates				
Quantity ordered	1 Pair or 1-2 birds	2 Pairs or 3-4 birds	3 Pairs or 5-6 birds	4 Pairs or 7-8 birds
Add per order	\$122.50	\$147.50	\$270.00	\$295.00

White King & Giant White Hubble Utility Pigeons Shipping Rates				
Quantity ordered	1 Pair or 1-2 birds	2 Pairs or 3-4 birds	3 Pairs or 5-6 birds	4 Pairs or 7-8 birds
Add per order	\$127.50	\$152.50	\$280.00	\$305.00

Giant Runt Utility Pigeon Shipping Rates				
Quantity ordered	1 Pair or 1-2 birds	2 Pairs or 3-4 birds	3 Pairs or 5-6 birds	4 Pairs or 7-8 birds
Add per order	\$127.50	\$255.00	\$382.50	\$510.00

Dove Shipping Rates				
Quantity ordered	1 Pair or 1-2 birds	2-3 Pairs or 3-6 birds	4 Pairs or 7-8 birds	5-6 Pairs or 9-12 birds
Add per order	\$117.50	\$122.50	\$142.50	

Exotics Shipping Rates (Exotics Cannot Ship with other Doves or Pigeons)				
Quantity ordered	1 Pair or 1-2 birds	2-3 Pairs or 3-6 birds	4 Pairs or 7-8 birds	5-6 Pairs or 9-12 birds
Add per order	\$117.50	\$122.50	\$142.50	

Adult Ornametal Birds (Ships via Delta Airlines)		
Page	Breed	1 Pair
127	Black Australian Swans	\$500.00
127	East African Crane	\$500.00
127	Trumpeter Swans	\$500.00
127	White Mute Swans	\$500.00
127	Whooper Swans	\$500.00

4 in 1 Powder	45	Custom Bands	84	Heat Shrink Bags	77
A		Cutting Gloves	75	Heated Waterer Base	35
Acidified Copper Sulfate	43	D		Heaters	20
Adult Birds	125-126	Decor	87	Hen Aprons	43
Amprol	44	Decoy Eggs	63	Heritage Birds	93-99
ARPU Bands	84	Dewormer	80	Hog Rings	58
Automatic Waterers	31	Diamond Doves	138-139	Hoods	85
B		Diatomaceous Earth	43	Humidity Pads	8
Baby Chick Feeders	23	Disease Prevention	40-45	Hybrid Egg Layer	92
Bacitracin Soluble	42	Disinfectant	44	Hygrometers	17
Bait/Bait Stations	59	DIY Coop Plans	54	I	
Bandettes	83	Doves	138-141	Identification Bands	82-84
Bands	83-84	Drink Stick	32	Imprinted Bands	84
Bantam	106-111	Duck Wax	74	Incubator Disinfectants	11
Baskets	67	Ducks	116-117	Incubator Rack	11
Battery Brooders	22	Durvet	41	Incubator Thermometers	17
Biosecurity	40	Dutch Oven	89	Incubators	5-15
Bird Crates	79-81	E		Ivermectin	44
Bird Pricing	91-143	Egg Accessories	67	J-K	
Bird Transportation	79-81	Egg Basket	67	Jars	23, 30
Bitfitter	85	Egg Candling	16	Jiffy Wing Bands	84
Blu-Kote	43	Egg Cartons	64	Killing Cones	76
Books	86	Egg Flats	65	Kitchenware	88-89
Box Brooders	22	Egg Handling	66	Kitchen Scale	17
Boxes for Transport/Shipping	79	Egg Layer	92	Knives	75
Breeding Saddle	43	Egg Racks	11	L	
Brooder Kits	18	Egg Stamps	67	Labels	78
Brooder Thermometer	17	Egg Trays	65	Lamp Brooders	20
Brooder	18-22	Egg Wash	66	Lamps	20-21
Bumpa Bits	85	Egg Washers	66	Large Capacity Feeders	27
C		Eggs - Quail	123	Leg Bands	82-84
Cabinet Incubator Accessories	11	Eggs for Sale Sign	67	Live Bird Shipping Carton	79
Cabinet Incubators	5-10	Electric Fencing	45-51	Live Bird Shipping Rates	146
Cage Building	55-58	Energizer	49	Live Traps	59
Cage Cups	34	Exotic Doves & Pigeons	142	Livestock Medications	44
Candling	16	F		Lung Removal	75
Cannibalism Control- Peepers Bits	85	Fake Eggs	63	M	
Cannibalism Control- Topical	43	Fantail Pigeons	129	Marek's Disease	42
Cartons - Eggs	64	Feed Supplements 7	41	Mason Jar Feeder/Founts	23
Castors for Incubators	8	Feeders	24-27	Meat Bird	91
Charger	49	Fencing	46-51	Meat Turkey	114
Chick Brooder	19-22	Fish & Game Cleaning Table	74	Medications	44
Chicken Treats	38-39	Flock Maintenance	41-44	Metal Waterers	28
Chicken Run and Wire	46-51	Food Safety Labels	78	Mite and Lice Treatment	44
Chicks	91-111	Food Sealer	78	Mouse Bait	59
Chlorhexidine	44	Freezer Bags	78	Mugs	88
Chukar	120	Fryer	88	N	
Cleaning Tables	74	G		Nesting Boxes	61-62
Cocciostat	44	Game Bird Netting	56	Nesting Eggs	63
Cochin	100	Geese	118-119	Nesting Pads	63
Conversion Boxes	61	Gifts	87	Netting	56
Cookware	88-89	Gloves	75	Nipples	32, 33
Coop Disinfectant	44	Grubs	38-39	Nite Guard	59
Coop Doors	55	Guineas	112-113	NPA Bands	84
Coop Heaters	20	H		Numbered Bands	83
Coops & Pens	52-54	Hand Tools	58	O	
Corid	44	Hanging Feeders	26	Old English	104
Corner Post	48	Hanging Nipple Waterer	34	Omega 3	41
Cornish Rock	91	Health Aids	41-44		
Crested/Fancy Chicks	101-102	Heat Brooders	19		
Cups	34	Heat Lamps	20		

O (continued)			
Oregano	42	Sealed Pigeon Bands	84
OregaPro	42	Shears	75
P		Shipping Cartons	79
Packaging	78	Shipping Rates	143
Pads	8	Show Pigeons	130
Peachick	124	Shrink Bags	77
Peck N' Grow	37	Signs	87
Peepers	85	Skunk Traps	59
Pens & Coops	46	Solar Energizer	49
Permanent ID	84	Spices	89
Permethrin	43	Spiral Bands	83
Pheasant & Chukars	120	Squab	128
Pick No More	43	Stamps	67
Pigeon Bands	84	Stand Up Brooder	21
Pigeon Medications	45	Standard Breed Chicks	92
Pigeon Waterers	45	Starplate Building System	60
Pigeons	128	Styrofoam Incubators	15
Pin Feather Wax	74	Swans & Cranes	127
Plastic Waterers	29	T	
Pliers for Bands	84	T Post Driver	50
Pliers for Rings and Clamps	58	Table	74
Pluckers	70-73	Table Top Incubators	12
Pop Up Thermometer	78	Tek Trol Disinfectant	11
Poultry Crates	78	Temporary Bands	83
Poultry Shrink Bags	77-78	Test for Salmonella	43
Poults	115	Thermometers	17
Predator Control	59	Toe Punch	84
Prevention	44	Transportation	79
Probiotics	37	Traps	59
Processing	74	Trays - Egg	65
Processing Labels	78	Treats	38
Processing Table	74	Trough Feeders	23
Protective Clothing	75	Tumblers	132
Prozap Garden & Poultry Dust	43	Turkeys	114
Pullorum Antigen	43	Turners	15
		Tylosin	45
Q-R		U-Z	
Quail Eggs	122	Utility Pigeons	128
Quails	122	Vacuum Sealer	78
Racing Homers	134	VetRx	42
Racks - Egg	11, 15	Vitamins & Electrolytes	37, 41
Rain Shield Feeder	27	Washers - Egg	66
Range Feeder	27	Waterers	28
Restraining Cones	76	Watering System	32
Reusable Wax	74	Wax	74
Ringneck Doves	140	Wing Bands	84
Rodent Traps	59	Wonder Grubs	38
Roll Out Bottom Converter	61	Wormer Deluxe Powder	45
Roll Out Nest Boxes	61	Wound Spray	43
Rollers & Tumblers	132	Zip Tie Numbered Bands	83
Rooster Rub	89	Zip Ties	78
RopaPoultry	42	Zyfund Dewormer	42
Runs	56		
S			
Saddle	43		
Salmonella Test	43		
Sanitizer	40		
Scalders	68-69		
Scales	17		
Scissors	75		
ScotBeak Guards	85		

FREE SHIPPING - Free shipping applies to most orders placed from this catalog over \$150 sent standard ground service by our carrier of choice within the lower 48 states. Custom items not shown in this catalog may be excluded from the free shipping offer, items marked with  are excluded from the free shipping offer. The items included/excluded from the offer are subject to change without notice. Due to the ever-rising cost of outbound shipping, any order with back-ordered item(s) may be held until the back-ordered item(s) arrives.

FREIGHT CHARGES - You pay all freight costs unless otherwise stated or agreed upon. Next day, 2 day and 3 day air shipments are available at an additional cost. Freight is figured by dimensional weight, call 888-697-2444 for freight quote.

ONLINE ORDERS - Online orders placed after 4PM CST are processed the following business day. Web orders placed from Friday 4PM CST - Monday 8AM CST will not be processed until Monday at 8AM CST. Expedited order shipping times are subject to the carrier's daily pickup at the order's branch location warehouse. For more details on expedited shipping times please call us or visit our website's Shipping Information page.

CONVENIENT WAYS TO PAY - Visa, Discover, MasterCard, American Express, Check with Order, Check by Phone, Wire Transfer and PayPal*. (*Online only).

OVERPAYMENTS - Overpayments may be refunded or credited to your account.

ORDER FOR EXPORT - Quotes on orders for export may include shipping, special packaging, and documentation at a customer's request. Please call us for quotes. All shipments for export are subject to prepayment in U.S. Funds. The customer agrees that they will be responsible for all product, shipping and destruction expenses if any ordered product is rejected by the importing country's customs agency. Quotes do not include fees charged by the destination country.

ADDITIONAL CHARGES

For each Address Correction - \$15.00

For each Acknowledgment of Delivery - \$5.00

For each Call Tag Received - \$9.00

For each Live Bird Cancellation - \$15.00

Canceled orders that have been fulfilled in our warehouse may be subject to a 10% restocking fee

Fuel surcharge subject to change without notice.

LIVE BIRDS

1. Shipping is not included in the price for baby chicks, adult birds, pigeons, and doves. Special handling is required.
2. All live bird orders must have a contact phone number and physical address.
3. We do not take cancellations via email, voicemail or online messaging. Live birds and fertilized eggs can only be shipped to an address in the lower 48 states.
4. Adult birds are shipped via Express Mail.
5. Chicks and eggs are shipped via Priority Mail.
6. Health of the birds guaranteed for the first 48 hours after delivery. We must be notified within the 48 hours if any problems occur.
7. Live bird cancellation fee is \$15.00 on all orders. You must call in to cancel a live bird order.
8. Orders cannot be canceled within 12 days of ship date.
9. No changes allowed once order has been submitted.

SALES, FREIGHT & WARRANTY INFORMATION

WARRANTY - Stromberg's warrants its equipment to be free of functional defects in material and workmanship. Returns must be made within 30 days. You may be asked to return the merchandise in order to receive a refund. Refunds can include the purchase price along with all transportation charges if the product is found defective. Warranty does not cover damage to equipment arising from alteration, abuse or use of product for other than its intended purpose. Photos must be supplied for damaged product replacement.

DAMAGED FREIGHT - All merchandise is shipped "F.O.B. Shipping Point". This is a legal term that means all merchandise becomes your property as soon as we give it to the freight carrier. The freight carrier is responsible for complete and safe delivery of your merchandise. It is your responsibility to inspect the merchandise when it is delivered. If the freight carrier fails to deliver your merchandise in good condition, it is your responsibility to note the damage before signing for it. Contact us so that we can file a claim with the carrier on

your behalf. Photos of the package, shipping label and damaged merchandise are required to file a claim and receive a refund or replacement.

SPECIAL ORDERS - Special orders may require a deposit.

PICK UP ORDERS - A call before you stop by helps us serve you in a more timely manner. In most cases, we will have your order ready for pick up upon your time of arrival if given prior notice.

LIABILITY - Our liability is limited to the purchase price paid for any item. We make no warranty or representation, express or implied except all products conform to the description provided by the manufacturer on sales literature or product labels.

RETURNED MERCHANDISE - If you need to return an item, we accept returns under the following conditions:

1. Contact us for a return authorization number.
2. Item must be in like new condition.
3. Item must be returned within 30 days of receipt.
4. Original receipt is required.
5. In most cases a restocking fee of 20% will be charged. We cannot accept returns on hazardous materials.
6. Returns will be processed within 14 days of receiving of the returned product.
7. Stromberg's is not responsible for return items lost in transit. You must retain your own tracking numbers and handle your own claims on return items.

REPLACING MERCHANDISE - When Stromberg's ships a replacement product to you due to damage or an incorrect product, there will be an additional charge for the new product sent. However, a credit will be applied at the time of the return of the incorrect product.

PRICES - Stromberg's will invoice all orders on the basis of prices which are in effect at the time of shipment. We reserve the right to change catalog prices if we deem it necessary. Please feel free to confirm prices at any time. Stromberg's is not responsible for typographical errors.

ORDER DISCREPANCIES - Check all orders immediately upon receipt and contact us within 10 days on any discrepancies.

PRODUCT SUITABILITY - Due to many state and local codes and regulations regarding sales, construction, installation and use of products for certain purposes, we cannot guarantee compliance in every situation. We attempt to assure that all products comply with state and local codes and regulations, so before you purchase and use a product please review both the product application and local codes and regulations. Be sure that the product, its installation and its use will comply with those codes and regulations.

HOURS - Call or visit our website for store hours. Our phones are answered 7am to 7pm CST for ordering and customer service. Place orders by phone at 888-697-2444, by fax at 218-216-1042, or by email address at info@strombergschickens.com Orders may also be placed online at www.strombergschickens.com

STATE SALES TAX - When applicable, we are required to collect sales tax by law. Exemptions for sales tax will be allowed if you have either a signed Certificate of Resale or an Exemption Certificate. The tax forms vary by state, please call for details. Law requires that we have these certificates on file before any tax exemption may be applied.

HOLIDAY CLOSINGS - We are closed New Year's Eve, New Year's Day, Memorial Day, Independence Day, Labor Day, Thanksgiving Day and the following Friday, Christmas Eve and Christmas Day.

CREDIT CARDS - Stromberg's reserves the right to preauthorize credit and/or debit cards. No money leaves your account until the purchase clears but the hold is active until the actual transaction is settled. When there's a hold on your account, it lowers your available balance. Stromberg's is not responsible for overdraft fees resulting from the pre-authorization of your card.



Sales and Support: 888-697-2444
International: 218-675-6688 Fax: 218-216-1042
www.strombergschickens.com
info@strombergschickens.com

SAFE & EFFECTIVE HEATING

BROOD YOUR CHICKS OR HEAT YOUR CHICKEN COOPS WITH THIS ONE-OF-A-KIND HEAT LAMP WITH BUILT-IN SAFETY FEATURES TO GIVE YOU PEACE OF MIND!



URNS OFF WHEN
TILTED OVER 30°



THREE WAY SWITCH
ENABLES CHANGING
BETWEEN 100% OR 50%
POWER & POWER OFF



DURABLE CERAMIC
SOCKET FITS EASY-TO-FIND
STANDARD 250W BULB



AVOID DEVASTATING COOP AND BARN FIRES BY USING THIS HEAT LAMP WITH A BUILT-IN SAFETY SWITCH!

This fire-resistant chick and coop heater is a safe and reliable, smaller heat lamp! When this heat lamp is tipped past 30° the safety switch engages and turns off the unit, giving you piece of mind. This lamp has multiple uses besides being an awesome addition to your brooders or coops. It's also great for use with baby goats, lambs, or even dogs. Also, there is no need to search for a special bulb, this heat lamp uses an easy-to-find, standard 250W bulb.

ONLY
\$49.95

FREE SHIPPING ON MOST ORDERS \$150+



501 1st Street S Hackensack, MN 56452
STROMBERGSCHICKENS.COM
888-697-2444



THOUSANDS
of products



EXCLUSIVE
online sales



SIX RETAIL
Locations



CUSTOMER SERVICE
for all your needs

*Start shopping
now!*



WE HAVE EVERYTHING YOU NEED FOR YOUR FLOCK TO THRIVE!

We reserve the right to change prices at any time. Please check online for details.

STORE LOCATIONS

CA

Woodland, CA
500 Santa Anita Drive
Woodland CA 95776

FL

Winter Haven, FL
301 Bert Schulz Blvd
Winter Haven FL 33881

KY

Clarkson, KY
807 W Main St
Clarkson KY 42726

MN

Hackensack, MN
501 1st Street S
Hackensack MN 56452

PA

Wilkes-Barre, PA
485 Stewart Rd
Wilkes-Barre PA 18706

TX

Marshall, TX
1600 Commerce St
Marshall TX 75672

NEW ITEMS

Check inside our 2025 Stromberg's Catalog for the latest
and greatest in the poultry world!

Your First Chicken Coop
Kick-start your poultry hobby
with this adorable coop!
Page 52



Wonder Coop Spray
Freshen up your coops with
the latest addition to our
Wonder Product Line!
Page 36



Silo Feeder & Waterer
These silo style feeders &
waterers are a breeze to fill!
Page 24 & 28



*Look for the "NEW"
icon to see these
great products
and more!*

